



**KÜBERIT<sup>®</sup>**  
**INNOVATIVE PROFILES**

## IN A WORLD OF DESIGN AND ARCHITECTURE

even the smallest details do not go unnoticed. They are desired by the professional installer, architect, designer, and end user. As one of the only manufacturers supplying transitions for every flooring category, Küberit is an innovator of the flooring world. Made with an eye for perfection and manufactured for residential as well as heavy commercial use, Küberit provides the perfect transition solution for every flooring project. With Küberit, the attention is in the details, providing aesthetically pleasing and thoughtfully designed solutions to complement and enhance the overall style of any space.

# KÜBERIT®

ENGINEERED FOR PERFECTION.  
DESIGNED FOR DISTINCTION.

**EVERY PROFILE TELLS A STORY**

For over 150 years, Küberit has been known for designing and manufacturing innovative profile solutions across the globe, serving customers in over 67 countries. Our portfolio includes more than 400 different profiles and 16,000 SKUs for use with all flooring types. Today, Küberit is still committed to providing the highest quality German engineering, along with the latest cutting-edge technology which has yielded over 150 patents and specific designs for the professional installer and the architectural and design community.

**Our Vision**

To continually innovate and create new products to serve and grow the North American market.

**Our Mission**

To provide profile solutions for all your project needs, by offering the largest selection of color and design options, while delivering and maintaining our best-in-class customer service.



Küberit's fully automated high-bay warehouse.

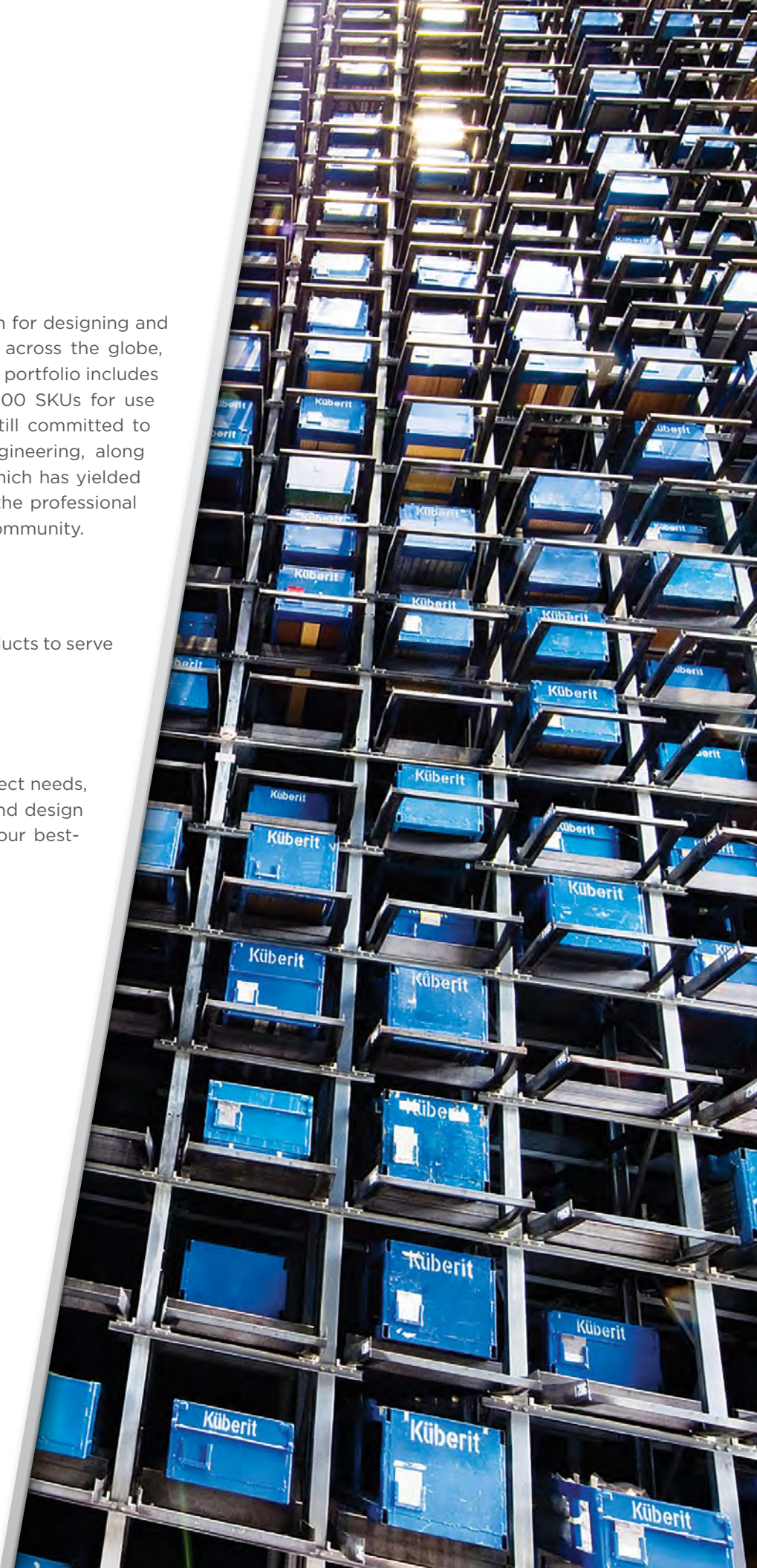

- KO** Küberit Original Profiles ..... 6
- KE** Küberit Expansion Profiles ..... 10
- KT** Küberit Transition Profiles ..... 12
- KR** Küberit Ramp Profiles ..... 18
- KS** Küberit Stair-Nosing Profiles ..... 24
- KC** Küberit Clip System Profiles ..... 32
- KW** Küberit Wall Protection Profiles ..... 36

**DEFINE YOUR SPACE** with profiles that work for you.  
With Küberit, you have a wide range of styles, sizes and finishes to choose from.

**KO Küberit Original Profiles**

KO-A ..... 7  
 KO-A-BG1 ..... 7  
 KO-B ..... 8  
 KO-C ..... 8  
 KO-D ..... 9

**KE Küberit Expansion Profiles**

KE-A ..... 11  
 KE-B ..... 11

**KT Küberit Transition Profiles**

KT-A ..... 13  
 KT-B ..... 13  
 KT-C ..... 14  
 KT-D ..... 14  
 KT-E ..... 14  
 KT-F ..... 15  
 KT-G ..... 15  
 KT-G-D1 ..... 15  
 KT-H ..... 16  
 KT-I ..... 16  
 KT-J ..... 16  
 KT-K ..... 17  
 KT-L ..... 17  
 KT-M ..... 17

**KR Küberit Ramp Profiles**

KR-A ..... 19  
 KR-B ..... 19  
 KR-C ..... 20  
 KR-D ..... 20  
 KR-E ..... 20  
 KR-F ..... 21  
 KR-G ..... 21  
 KR-H ..... 22  
 KR-I ..... 22  
 KR-J ..... 23

**KS Küberit Stair-Nosing Profiles**

KS-A ..... 26  
 KS-B ..... 26  
 KS-C ..... 27  
 KS-D ..... 27  
 KS-E ..... 28  
 KS-F ..... 28  
 KS-G ..... 29  
 KS-H ..... 29  
 KS-I ..... 30  
 KS-J ..... 30  
 KS-K ..... 30  
 KS-L ..... 31  
 KS-PVC ..... 31

**KC Küberit Clip System Profiles**

KC-D ..... 33  
 KC-M ..... 34

**KW Küberit Wall Protection Profiles**

KW-A ..... 38  
 KW-B ..... 38  
 KW-C ..... 38  
 KW-D ..... 39  
 KW-E ..... 39  
 KW-F ..... 39  
 KW-G ..... 40  
 KW-H ..... 40  
 KW-I ..... 40  
 KW-J ..... 41  
 KW-K ..... 41  
 KW-L ..... 42  
 KW-M ..... 42  
 KW-N ..... 42  
 KW-O ..... 43  
 KW-P ..... 43  
 KW-Q ..... 44  
 KW-R ..... 44  
 KW-S ..... 44  
 KW-T ..... 45

**Küberit Innovative Profiles are available in custom lengths, colors and finishes upon request.**

**Powder Coating**  
 Küberit offers powder coating of all aluminum profiles in RAL colors with three finish options: matte, semi-matte and high gloss.

In powder coating, an electrically conductive material is coated with powder resulting in a heavy duty protective coating for metal.

In this process, electrically charged parts of the coating powder and the material to be coated attract each other. The powder is electrically charged via an electrode in the spray gun. The workpiece is grounded, so that an electric field is formed between the material and the gun, which transports the powder particles to the surface of the material.

The subsequent thermal treatment of the coated materials at 160-200°C, cross-links the applied powder particles to form a smooth uniform surface.

The powder coatings used, based on polyamide, epoxy or polyester resins, provide protection against scratching, impact, corrosion and weathering. Powder coatings are available in almost all RAL colors and can be used for decorative purposes.

**Wood Decor**  
 Our natural looking wood decors are digitally printed paper foil with AC3 abrasion-resistant hot coating designed for light commercial and residential applications. The aluminum profile is wrapped with this high quality foil and obtains a natural look due to the wood grain patterning of the foil. The higher abrasion-resistant AC5 coating is designed for heavy commercial applications.

**Digital Printing**  
 Küberit also offers digital printing and color matching to any type of hard and resilient floor covering upon request with additional lead time.

Customized options require a minimum quantity and longer lead times are to be expected. Please contact your customer service representative for more details.

**888-284-7567**  
**info@kuberitusa.com**

Material Finishes	Insert Codes	Profile Options
<b>Aluminum Natural</b>  AN Natural	<b>KE - Inserts</b>  BK Black  GY Grey	 B = Bendable
<b>Anodized Aluminum</b>  A1 Silver  A2 Sand  A3 Bronze  A4 Black  AP Polished  AT Titanium	<b>KS - PVC Inserts</b>  1 Black  2 Brown  3 Anthracite  4 Light Grey  5 Beige Grey  6 Beige  7 Blue  8 Red  9 Fluorescent  10 Yellow	 C = Countersunk Drilled
<b>Stainless Steel</b> 304 (1.4301=V2A (E))  SP Polished  SB Brushed	<b>Symbols</b>  Double-Sided  ADA Compliant  Screws Included Metric TORX  Suggested Screws Phillips Flat Head Zinc-Plated	 P = Punched/Perforated
<b>Brass</b>  X1 Brass		 S = Self-Stick
<b>Wood Decor</b>  W1 Oak Light  W2 Oak Grey  W3 Oak Beige Grey  W4 Oak Cream  W5 Oak Light Grey  W6 Walnut  W7 Wenge		 U = Unpunched/Solid



## KÜBERIT ORIGINAL PROFILES

A universal profile joining many different types of floor coverings of different heights, for both residential and commercial applications. These modern decorative profiles, for finishing and edge protection, are available in a wide range of finishes which accentuate any flooring selection by creating harmony within the overall design.

- Resilient
- Laminate
- Wood
- Ceramic
- Natural Stone
- Carpet

KÜBERIT PROFILES...  
ALWAYS ON THE CUTTING EDGE.

NOTE: Color representation will vary between our catalog, website, printouts and monitor displays. These cannot technically represent the true color of the materials and the different finishes/colors. Please feel free to order samples of materials and colors from us.



## KÜBERIT ORIGINAL PROFILES

### KO-A

Pre-fit edge trim profile for resilient floorings such as LVT, LVP and sheet vinyl, laminate, wood, ceramic, natural stone and carpet:

- Protects edges and covers the cutting edge of the flooring
- Can be used for walls
- Installed prior to placing floor covering using adhesive
- Smooth surface

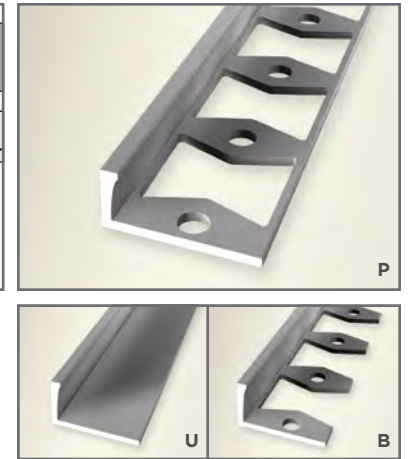
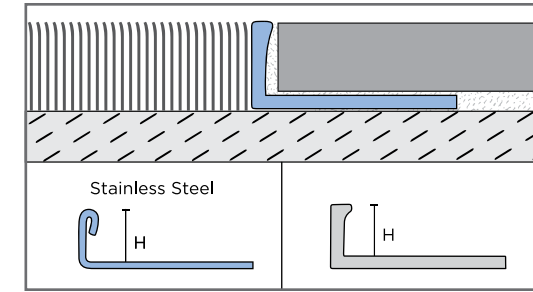

To determine the item number when ordering, select: Product Code-Finish-Option. (e.g. KO-A-030-AN-B)  
Please see page 48 for detailed ordering information.

KO-A			AN*			A1		A2	A3			A4	SP
Length 2.50m = 8' 2-1/2"	Product Code	Aluminum Natural \$/Length	Anodized Aluminum			Anodized Aluminum Bronze \$/Length			Anodized Aluminum Black \$/Length		Stainless Steel Polished \$/Length		
			Silver \$/Length	Sand \$/Length		U	P	B	U	P	B	P	P
H = mm - in.	KO-A-000-	U	P	B	U	P	B	U	P	B	P	P	
1 2mm 1/16"	KO-A-020-		✓				✓			✓		* ✓	
2 2.5mm 3/32"	KO-A-025-	✓	✓		✓	✓		✓	✓				
3 3mm 1/8"	KO-A-030-	✓	✓	✓	✓	✓	✓	✓	✓	✓	✓	✓	
4 4.5mm 3/16"	KO-A-045-		✓	✓		✓	✓	✓	✓	✓	✓	✓	
5 6mm 1/4"	KO-A-060-	✓	✓	✓	✓	✓	✓	✓	✓	✓	✓	✓	
6 8mm 5/16"	KO-A-080-	✓	✓	✓	✓	✓	✓	✓	✓	✓	✓	✓	
7 10mm 3/8"	KO-A-100-		✓	✓		✓	✓		✓	✓	✓	✓	
8 11mm 7/16"	KO-A-110-		✓	✓		✓	✓		✓	✓			
9 12.5mm 1/2"	KO-A-125-	✓	✓	✓	✓	✓	✓	✓	✓	✓		✓	
10 14mm 17/32"	KO-A-140-		✓			✓			✓				
11 15mm 9/16"	KO-A-150-	✓	✓		✓	✓		✓	✓		✓	✓	
12 18mm 11/16"	KO-A-180-		✓			✓			✓				
13 20mm 13/16"	KO-A-200-		✓			✓			✓				
14 22mm 7/8"	KO-A-220-		✓			✓			✓		✓	✓	

U = Unpunched/Solid P = Punched/Perforated B = Bendable \*AN - Best suited for floor applications \* Also available in white

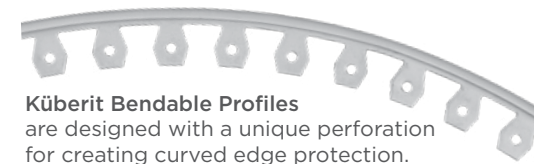

Küberit Bendable Profiles are designed with a unique perforation for creating curved edge protection.



These profiles can easily be bent on site to project specifications using the Küberit Bending Machine. Design your own unique curved connection for carpet, resilient, and ceramic floor coverings.

Bending Machine			
Size = cm	Size = in	Product Code	\$/Unit
1 37 x 40 x 23cm	14-9/16 x 15-3/4 x 9-1/16"	KO-A-BG1	✓

The Küberit bending machine is made of high grade, wear resistant polyamide and glass-fiber.  
NOTE: Discount not available for this item.



# KÜBERIT ORIGINAL PROFILES

## KO-B

Pre-fit edge trim profile for resilient floorings such as LVT, LVP and sheet vinyl, laminate and wood:

- Provides an expansion gap for floating floors
- Encloses the flooring edge
- Installed prior to placing floor covering using screws, nails or adhesive
- Smooth surface

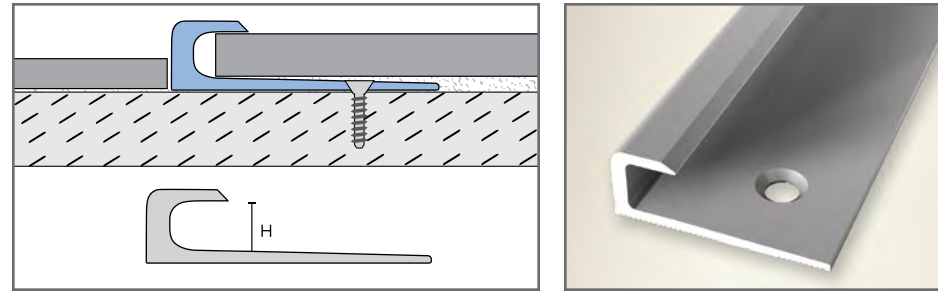
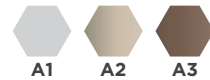

KO-B		A1	A2	A3
Length 2.50m = 8' 2-1/2"	Product Code	Anodized Aluminum Silver \$/Length	Anodized Aluminum Sand \$/Length	Anodized Aluminum Bronze \$/Length
H = mm - in.	KO-B-000-	C	C	C
1 3mm 1/8"	KO-B-030-	✓	✓	✓
2 5mm 7/32"	KO-B-050-	✓	✓	✓
3 7mm 9/32"	KO-B-070-	✓	✓	✓

C = Countersunk Drilled Suggested screws: Phillips No. 4, length 1"

## KO-C

Pre-fit edge trim profile for adhered or floating click-floorings, resilient such as LVT, LVP and sheet vinyl, laminate and wood:

- Provides an expansion gap for floating floors
- Encloses the flooring edge
- Installed prior to placing floor covering using screws, nails or adhesive
- Ridged surface

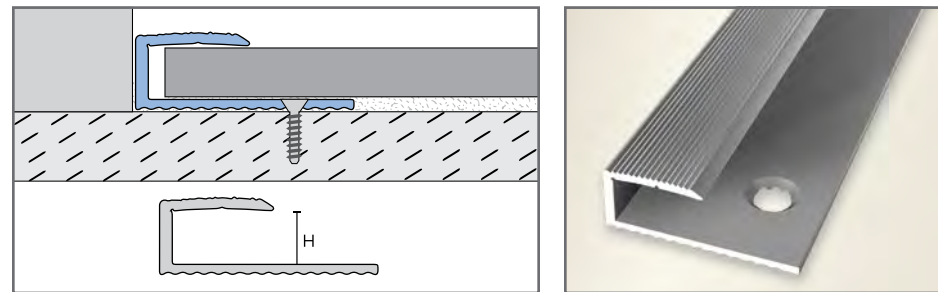
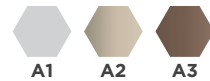

KO-C		A1	A2	A3
Length 2.50m = 8' 2-1/2"	Product Code	Anodized Aluminum Silver \$/Length	Anodized Aluminum Sand \$/Length	Anodized Aluminum Bronze \$/Length
H = mm - in.	KO-C-000-	C	C	C
1 8mm 5/16"	KO-C-080-	✓	✓	✓
2 10mm 3/8"	KO-C-100-	✓	✓	✓
3 12.5mm 1/2"	KO-C-125-	✓	✓	✓
4 15mm 9/16"	KO-C-150-	✓	✓	✓
5 18mm 11/16"	KO-C-180-	✓	✓	✓
6 22mm 7/8"	KO-C-220-	✓	✓	✓

C = Countersunk Drilled Suggested screws: Phillips No. 4, length 1"

# KÜBERIT ORIGINAL PROFILES

## KO-D

Pre-fit edge trim for laminate and wood:

- Provides an expansion gap for floating floors
- Encloses the flooring edge
- Double-sided
- Installed prior to placing floor covering using adhesive
- Smooth surface

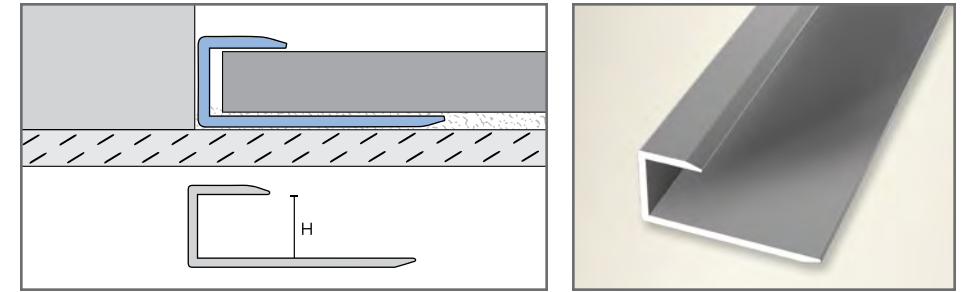
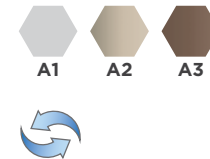

KO-D		A1	A2	A3
Length 2.50m = 8' 2-1/2"	Product Code	Anodized Aluminum Silver \$/Length	Anodized Aluminum Sand \$/Length	Anodized Aluminum Bronze \$/Length
H = mm - in.	KO-D-000-	U	U	U
1 8mm 5/16"	KO-D-080-	✓	✓	✓
2 10mm 3/8"	KO-D-100-	✓	✓	✓
3 12.5mm 1/2"	KO-D-125-	✓	✓	✓
4 14mm 17/32"	KO-D-140-	✓	✓	✓
5 15mm 9/16"	KO-D-150-	✓	✓	✓

U = Unpunched/Solid

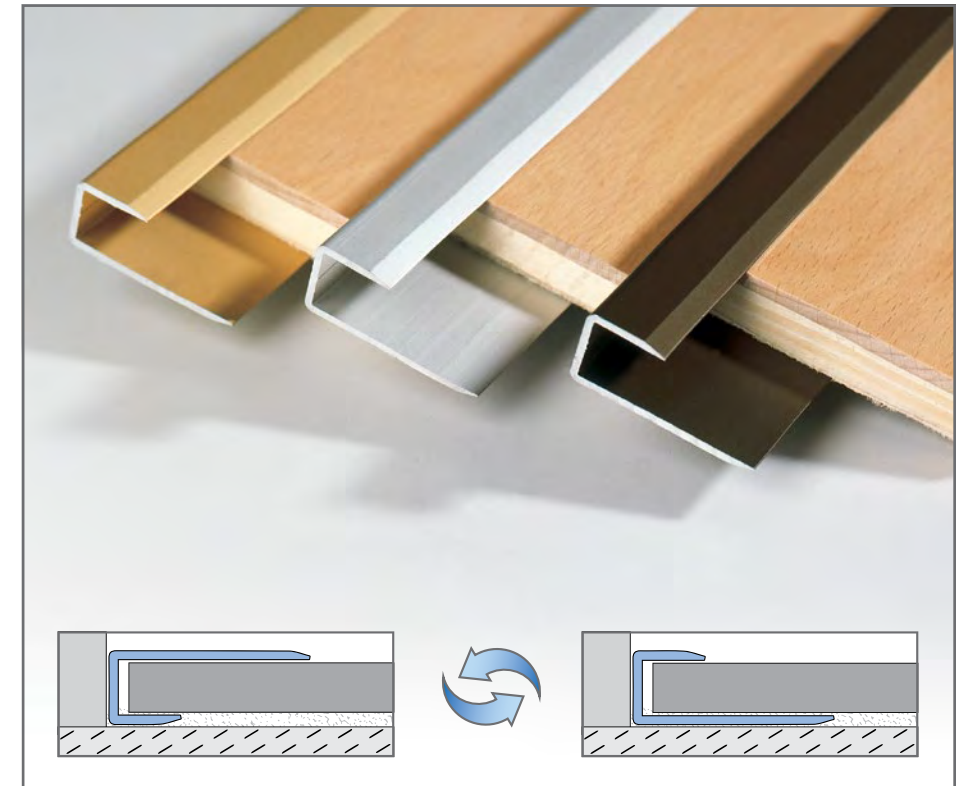



## KÜBERIT EXPANSION PROFILES

Many factors contribute to movement in the slab, stressing the importance of honoring movement, expansion and saw cut joints. These contemporary expansion profiles create an aesthetically pleasing look while also extending the life of the floor covering.

- Resilient
- Laminate
- Wood
- Ceramic
- Natural Stone
- Carpet

**HONOR THE JOINT...**  
WITH KÜBERIT PROFILES.

NOTE: Color representation will vary between our catalog, website, printouts and monitor displays. These cannot technically represent the true color of the materials and the different finishes/colors. Please feel free to order samples of materials and colors from us.



## KÜBERIT EXPANSION PROFILES

### KE-A

Pre-fit expansion joint profiles for all types of floor coverings:

- Expansion joint profile available with black or grey insert
- Enables an optimal bridging of screed expansion joints
- Can be used when floorings are subject to high mechanical stress
- Improves sound insulation
- Installed prior to placing floor covering using adhesive

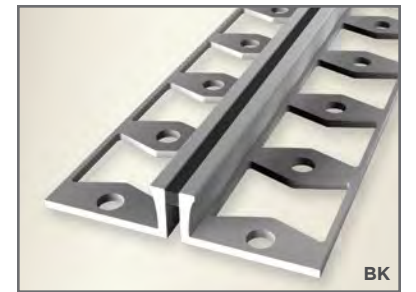
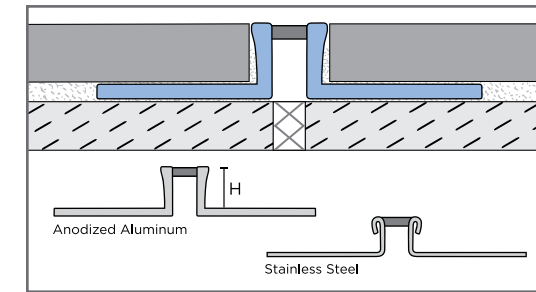

KE-A			A1		SP	
Length 2.50m = 8' 2-1/2"	Product Code		Anodized Aluminum Silver \$/Length		Stainless Steel Polished \$/Length	
H = mm - in.	KE-A-000-		BK	GY	BK	GY
1 3mm 1/8"	KE-A-030-		✓	✓	✓	✓
2 4.5mm 3/16"	KE-A-045-		✓	✓	✓	✓
3 6mm 1/4"	KE-A-060-		✓	✓	✓	✓
4 8mm 5/16"	KE-A-080-		✓	✓	✓	✓
5 10mm 3/8"	KE-A-100-		✓	✓	✓	✓
6 12.5mm 1/2"	KE-A-125-		✓	✓		
7 15mm 9/16"	KE-A-150-		✓	✓		

BK = Punched profile with black insert GY = Punched profile with grey insert

### KE-B

Pre-fit expansion joint profiles for all types of floor coverings:

- Special two-part patented expansion joint profile
- Expansion of +/- (2.5mm) 3/32" on both sides, installation without any tripping hazard
- (14mm) 17/32" visible top surface
- Installed prior to placing floor covering using adhesive (P) and/or with screws (C)

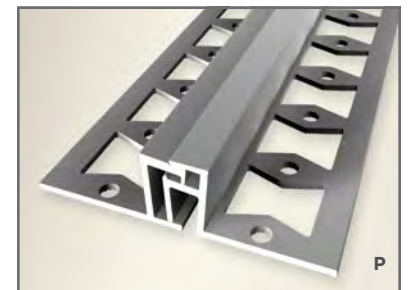
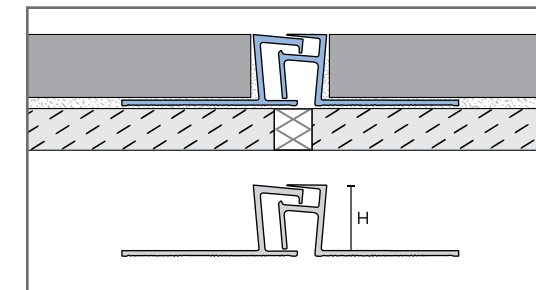



KE-B			A1		A2	A3
Length 2.50m = 8' 2-1/2"	Product Code		Anodized Aluminum Silver \$/Length		Anodized Aluminum Sand \$/Length	Anodized Aluminum Bronze \$/Length
H = mm - in.	KE-B-000-		P	C	C	C
1 2mm 1/16"	KE-B-020-			✓	✓	✓
2 3mm 1/8"	KE-B-030-			✓	✓	✓
3 4.5mm 3/16"	KE-B-045-			✓	✓	✓
4 6mm 1/4"	KE-B-060-	✓				
5 12.5mm 1/2"	KE-B-125-	✓				
6 15mm 9/16"	KE-B-150-	✓				

P = Punched/Perforated C = Countersunk Drilled  
KE-B-020, KE-B-030, KE-B-045 can be installed with screws or nails.  
Suggested screws: Phillips No. 4, length 1"



## KÜBERIT TRANSITION PROFILES

We offer a wide variety of modern and functional transitions for use between flooring surfaces and thresholds to protect the floor covering, while providing many different design options.

-  Resilient
-  Laminate
-  Wood
-  Ceramic
-  Natural Stone
-  Carpet

**MAKE A SMOOTH TRANSITION**  
...WITH KÜBERIT PROFILES.

NOTE: Color representation will vary between our catalog, website, printouts and monitor displays. These cannot technically represent the true color of the materials and the different finishes/colors. Please feel free to order samples of materials and colors from us.



## KÜBERIT TRANSITION PROFILES

### KT-A

Pre-fit transition and edge trim for resilient floor coverings such as LVT, LVP and sheet vinyl:

- For fully bonded floors adjacent to an existing lower flooring
- Installed prior to placing floor covering using screws, nails or adhesive
- Smooth surface
- Can be used for walls

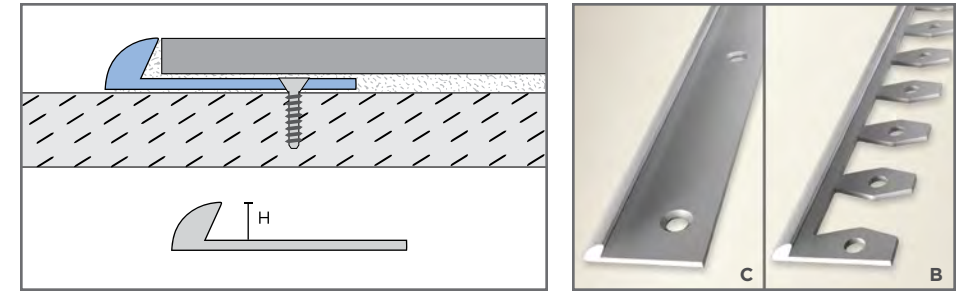

KT-A			A1		A2		A3		A4
Anodized Aluminum			Silver \$/Length		Sand \$/Length		Bronze \$/Length		Black \$/Length
	2.50m = 8' 2-1/2"	KT-A-000-	C	B	C	B	C	B	C
1	2mm 1/16"	KT-A-020-	✓		✓		✓		* ✓
2	2.5mm 3/32"	KT-A-025-	✓	✓	✓	✓	✓	✓	
3	3mm 1/8"	KT-A-030-	✓	✓	✓	✓	✓	✓	
4	4mm 5/32"	KT-A-040-	✓		✓		✓		
5	5mm 7/32"	KT-A-050-	✓	✓	✓	✓	✓	✓	

C = Countersunk Drilled B = Bendable Suggested screws: Phillips No. 4, length 1"  
\* Also available in white

### KT-B

Pre-fit transition and edge trim for resilient floor coverings such as LVT, LVP and sheet vinyl:

- For fully bonded floors of the same height
- Installed prior to placing floor covering using screws, nails or adhesive
- Smooth surface

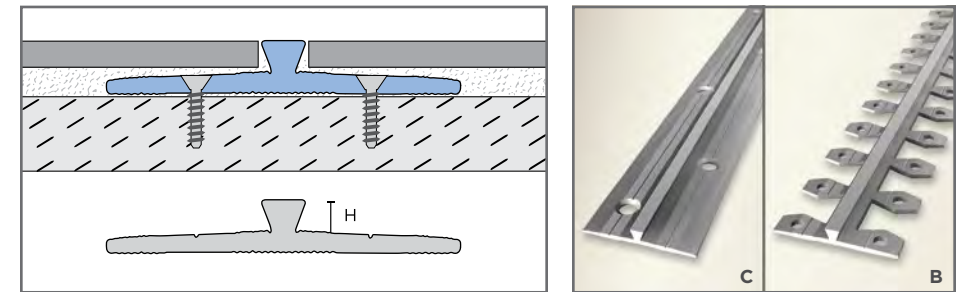
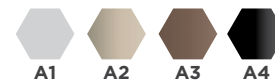

KT-B			A1		A2		A3		A4
Anodized Aluminum			Silver \$/Length		Sand \$/Length		Bronze \$/Length		Black \$/Length
	2.50m = 8' 2-1/2"	KT-B-000-	C	B	C	B	C	B	C
1	3mm 1/8"	KT-B-030-	✓	✓	✓	✓	✓	✓	* ✓

C = Countersunk Drilled B = Bendable Suggested screws: Phillips No. 4, length 1"  
\* Also available in white



# KÜBERIT TRANSITION PROFILES

## KT-C

Pre-fit transition and edge trim for resilient floor coverings such as LVT, LVP and sheet vinyl:

- For fully bonded floors of the same height
- Installed prior to placing floor covering using screws, nails or adhesive
- Smooth surface

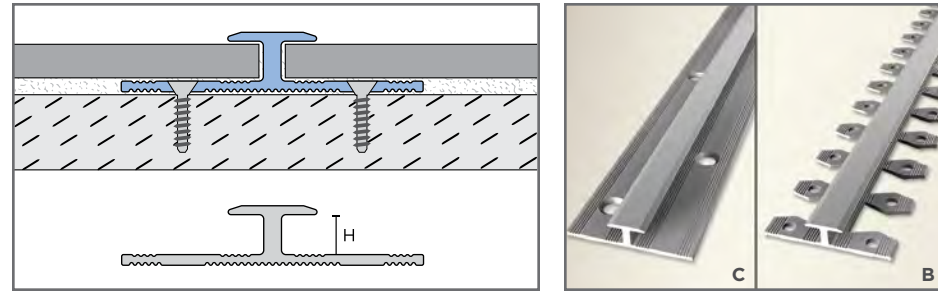

KT-C		A1		A2		A3	
Length	Product Code	Anodized Aluminum Silver \$/Length		Anodized Aluminum Sand \$/Length		Anodized Aluminum Bronze \$/Length	
H = mm - in.		C	B	C	B	C	B
1	4.5mm 3/16"	KT-C-000-	✓	✓	✓	✓	✓
		KT-C-045-	✓	✓	✓	✓	✓

C = Countersunk Drilled B = Bendable Suggested screws: Phillips No. 4, length 1"

## KT-D

Pre-fit transition and edge trim for resilient floor coverings such as LVT, LVP and sheet vinyl:

- For fully bonded floors adjacent to an existing higher flooring
- Installed prior to placing floor covering using screws, nails or adhesive
- Smooth surface

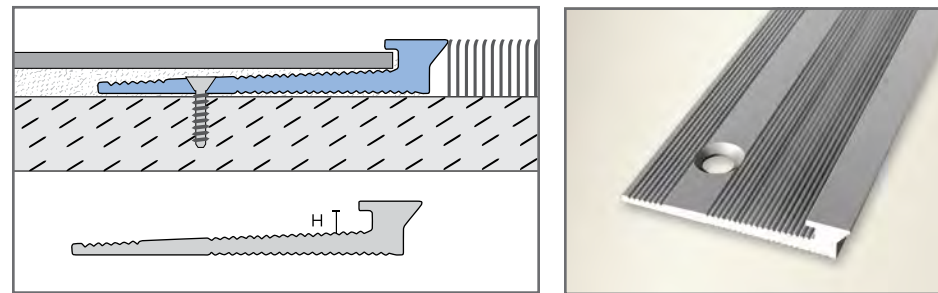
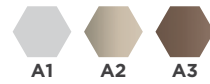

KT-D		A1		A2		A3	
Length	Product Code	Anodized Aluminum Silver \$/Length		Anodized Aluminum Sand \$/Length		Anodized Aluminum Bronze \$/Length	
H = mm - in.		C		C		C	
1	2.5mm 3/32"	KT-D-000-	✓	✓	✓	✓	✓
2	3mm 1/8"	KT-D-025-	✓	✓	✓	✓	✓
		KT-D-030-	✓	✓	✓	✓	✓

C = Countersunk Drilled Suggested screws: Phillips No. 4, length 1"

## KT-E

Pre-fit transition and edge trim for resilient floor coverings such as LVT, LVP and sheet vinyl:

- For fully bonded floors adjacent to an existing higher flooring
- Installed prior to placing floor covering using screws, nails or adhesive
- Smooth surface

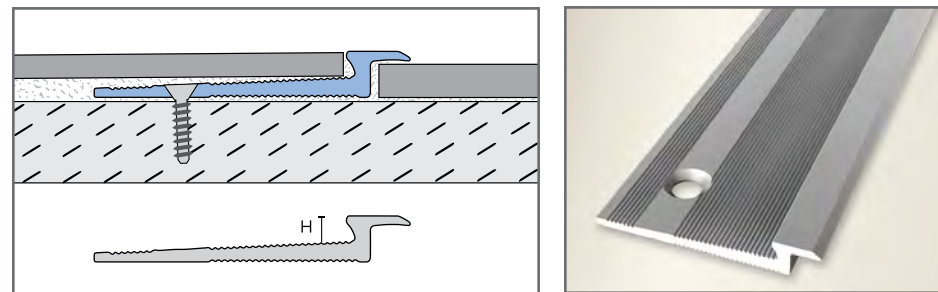

KT-E		A1		A2		A3	
Length	Product Code	Anodized Aluminum Silver \$/Length		Anodized Aluminum Sand \$/Length		Anodized Aluminum Bronze \$/Length	
H = mm - in.		C		C		C	
1	3mm 1/8"	KT-E-000-	✓	✓	✓	✓	✓
		KT-E-030-	✓	✓	✓	✓	✓

C = Countersunk Drilled Suggested screws: Phillips No. 4, length 1"

# KÜBERIT TRANSITION PROFILES

## KT-F

Pre-fit transition and edge trim for resilient floor coverings such as LVT, LVP and sheet vinyl:

- Can be used for walls and for a kitchen or bath backsplash
- Installed prior to placing floor covering using screws, nails or adhesive
- Smooth surface

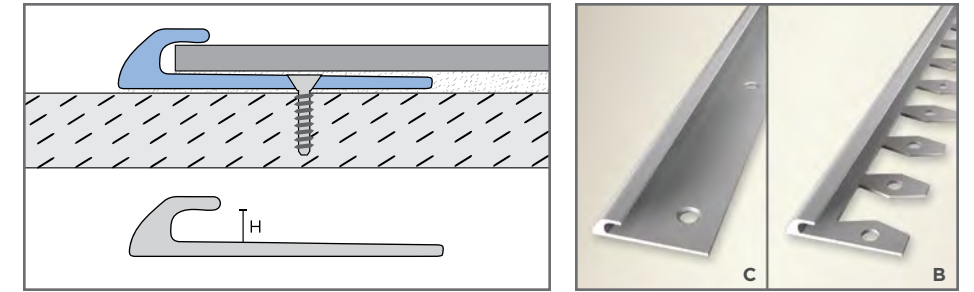

KT-F		A1		A2		A3		X1
Length	Product Code	Anodized Aluminum Silver \$/Length		Anodized Aluminum Sand \$/Length		Anodized Aluminum Bronze \$/Length		Brass \$/Length
H = mm - in.		C	B	C	B	C	B	C
1	3mm 1/8"	KT-F-000-	✓	✓	✓	✓	✓	✓
2	6mm 1/4"	KT-F-030-	✓		✓		✓	✓
		KT-F-060-	✓		✓		✓	✓

C = Countersunk Drilled B = Bendable Suggested screws: Phillips No. 4, length 1"

## KT-G

Retrofit transition for resilient, laminate, wood and ceramic floor coverings:

- For floor coverings of same height or minimal height differences
- Various wood options available
- Installed after placing floor coverings using adhesive or Rib Dowels
- Smooth surface ADA Compliant

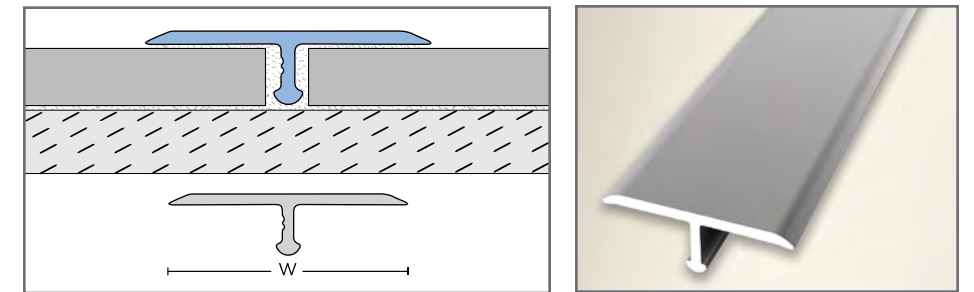

KT-G		A1		A2		A3		SP	W*
Length	Product Code	Anodized Aluminum Silver \$/Length		Anodized Aluminum Sand \$/Length		Anodized Aluminum Bronze \$/Length		Stainless Steel Polished \$/Length	Wood Decor \$/Length
W = mm - in.		UB		UB		UB		U	UB
1	14mm 17/32"	KT-G-140-	✓	✓	✓	✓	✓	✓	✓
2	28mm 1-1/8"	KT-G-280-	✓	✓	✓	✓			✓

**NOTE:** Size to width, not height. \*For Wood Decor options please refer to page 5. KT-G-140 is ADA Compliant.  
UB = Unpunched Bendable (Bending radius: 400mm) U = Unpunched/Solid (Not bendable, for same height flooring)

KT-G-D1 Rib Dowel for KT-G			
Length	Product Code	\$/Packet	
W = mm - in.			
1	6mm 1/4"	KT-G-D1	✓

14 dowels per packet = Typical quantity required for one length @ 2.5m = 8' 2-1/2"

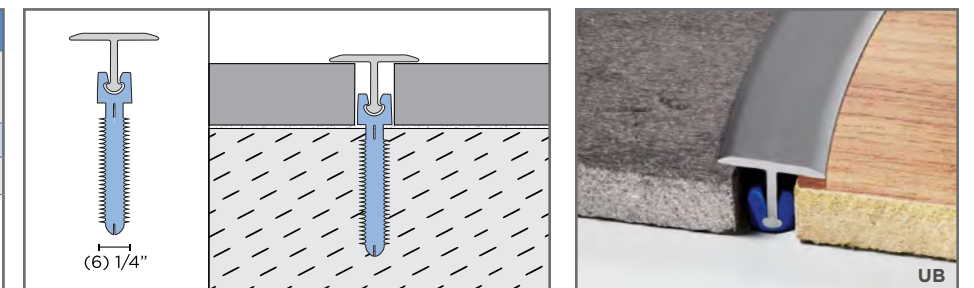

# KÜBERIT TRANSITION PROFILES

## KT-H

Pre-fit transition for resilient floor coverings such as LVT, LVP and sheet vinyl, laminate, wood and carpet:

- Flexible bending options for adapting to different flooring heights
- Installed using screws
- Ridged surface

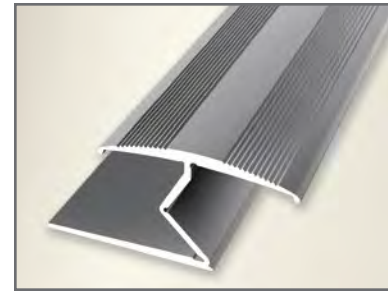
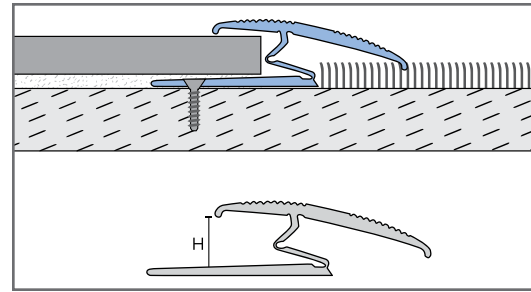
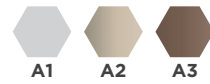

KT-H		A1	A2	A3
Length 2.50m = 8' 2-1/2"	Product Code	Anodized Aluminum Silver \$/Length	Anodized Aluminum Sand \$/Length	Anodized Aluminum Bronze \$/Length
H = mm - in.	KT-H-000-	C	C	C
1 8mm 5/16"	KT-H-080-	✓	✓	✓
2 15mm 9/16"	KT-H-150-	✓	✓	✓

C = Countersunk Drilled Suggested screws: Phillips No. 4, length 1"

## KT-I

Retrofit transition for resilient floor coverings such as LVT, LVP and sheet vinyl, laminate, wood, ceramic and natural stone:

- For floor coverings of same height or minimal height differences
- Installed using self-stick
- Protective film should be removed after installation
- Smooth surface

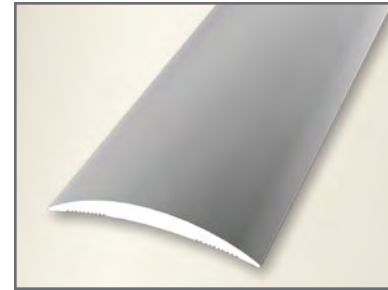
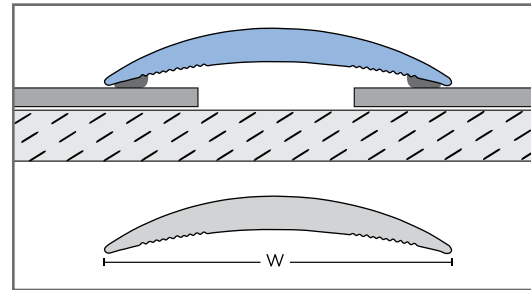

KT-I		A1	A2	A3	A4
Anodized Aluminum		Silver \$/Length	Sand \$/Length	Bronze \$/Length	Black \$/Length
Length 2.50m = 8' 2-1/2"	KT-I-000-	S	S	S	S
1 30mm 1-3/16"	KT-I-300-	✓	✓	✓	
2 40mm 1-9/16"	KT-I-400-	✓	✓	✓	* ✓

NOTE: Size to profile width, not height. S = Self-Stick \* Also available in white

## KT-J

Retrofit transition for carpet floor coverings:

- Retrofit for same height carpets
- Heavy duty
- Installed using screws provided
- Ridged surface

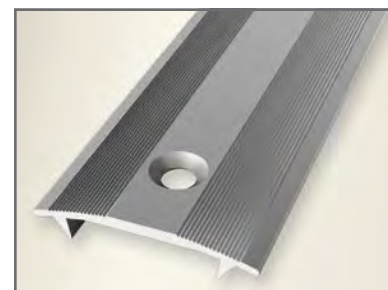
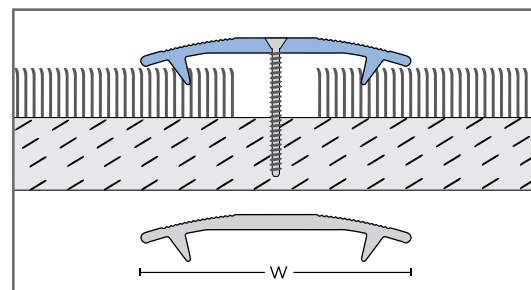
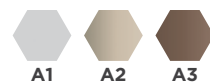

KT-J		A1	A2	A3
Length 2.50m = 8' 2-1/2"	Product Code	Anodized Aluminum Silver \$/Length	Anodized Aluminum Sand \$/Length	Anodized Aluminum Bronze \$/Length
W = mm - in.	KT-J-000-	C	C	C
1 35mm 1-3/8"	KT-J-350-	✓	✓	✓

NOTE: Size to profile width, not height. C = Countersunk Drilled Screws included

# KÜBERIT TRANSITION PROFILES

## KT-K

Retrofit transition for resilient floor coverings such as LVT, LVP and sheet vinyl, wood and ceramic:

- Retrofit for same height flooring
- Heavy duty
- Extra wide
- install using screws provided
- Ridged surface
- ADA Compliant

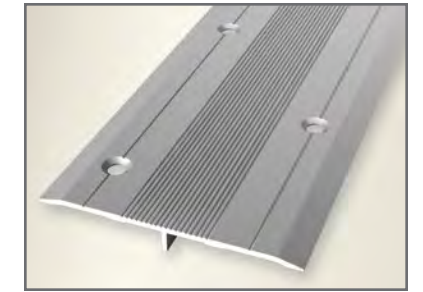
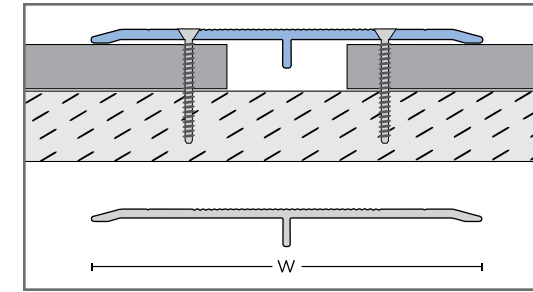
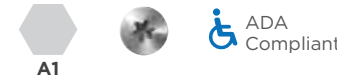

KT-K		A1
Length 2.50m = 8' 2-1/2"	Product Code	Anodized Aluminum Silver \$/Length
W = mm - in.	KT-K-000-	C
1 140mm 5-1/2"	KT-K-1400-	✓

NOTE: Size to profile width, not height.  
C = Double Countersunk-Offset Drilled Screws included

## KT-L

Retrofit transition for resilient floor coverings such as LVT, LVP and sheet vinyl, wood and ceramic:

- Ideal for retrofits with same height flooring
- Heavy duty
- Installed using self-stick
- Protective film should be removed after installation
- Smooth surface

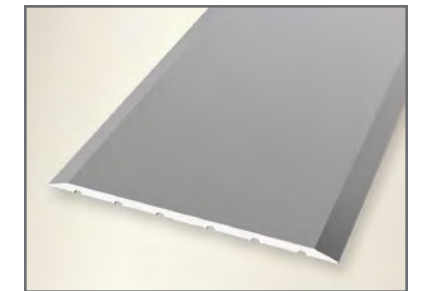
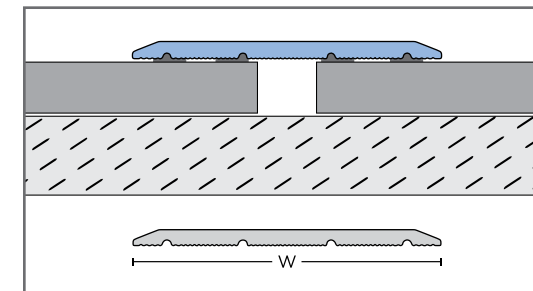
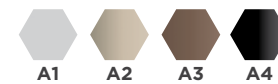

KT-L		A1	A2	A3	A4
Anodized Aluminum		Silver \$/Length	Sand \$/Length	Bronze \$/Length	Black \$/Length
Length 2.50m = 8' 2-1/2"	KT-L-000-	S	S	S	S
W = mm - in.	KT-L-000-	S	S	S	S
1 25mm 1"	KT-L-250-	✓	✓	✓	✓
2 40mm 1-9/16"	KT-L-400-	✓	✓	✓	✓
3 80mm 3-1/8"	KT-L-800-	✓	✓	✓	✓

NOTE: Size to profile width, not height. S = Self-Stick

## KT-M

Retrofit transition for resilient floor coverings such as LVT, LVP and sheet vinyl, laminate, wood and ceramic:

- Ideal for retrofits with same height flooring
- Heavy duty
- Installed using self-stick
- Ridged surface

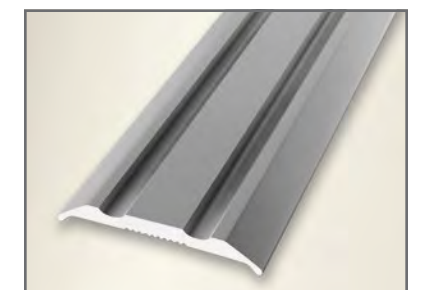
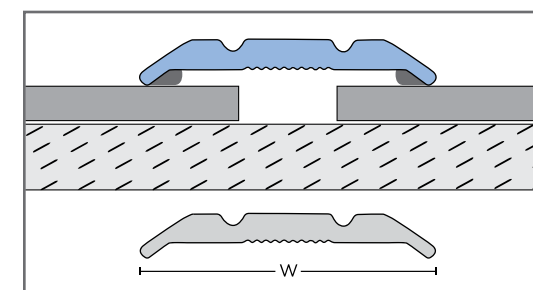
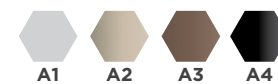

KT-M		A1	A2	A3	A4
Anodized Aluminum		Silver \$/Length	Sand \$/Length	Bronze \$/Length	Black \$/Length
Length 2.50m = 8' 2-1/2"	KT-M-000-	S	S	S	S
1 25mm 1"	KT-M-250-	✓	✓	✓	✓

NOTE: Size to profile width, not height. S = Self-Stick



## KÜBERIT RAMP PROFILES

Edge protection that provides a smooth sloped transition from one elevation to another, eliminating trip hazards. While being aesthetically pleasing, these profiles are designed for heavy commercial applications particularly where wheeled carts are used.

- Resilient
- Laminate
- Wood
- Ceramic
- Natural Stone
- Carpet

KR-A-030-A3-C

NOTE: Color representation will vary between our catalog, website, printouts and monitor displays. These cannot technically represent the true color of the materials and the different finishes/colors. Please feel free to order samples of materials and colors from us.

## KÜBERIT RAMP PROFILES

### KR-A

Pre-fit ramp profile for resilient floor coverings such as LVT, LVP and sheet vinyl:

- Solid commercial transition to adjacent lower flooring
- Installed prior to placing floor covering using adhesive or screws
- Ridged surface

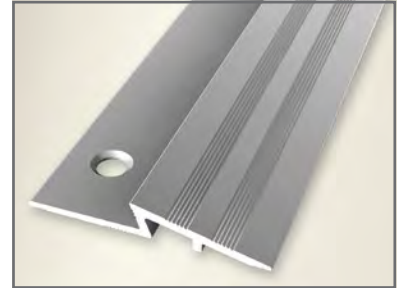
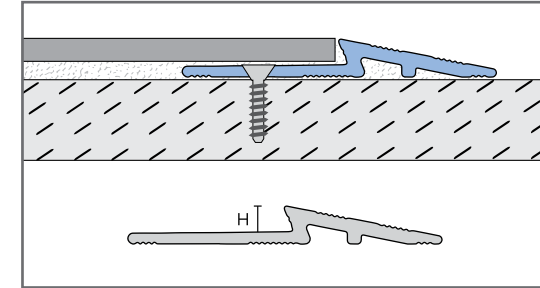

KR-A			A1	A2	A3
Length 2.50m = 8' 2-1/2"	Product Code	Anodized Aluminum Silver \$/Length	Anodized Aluminum Sand \$/Length	Anodized Aluminum Bronze \$/Length	
H = mm - in.	KR-A-000-	C	C	C	
1 3mm 1/8"	KR-A-030-	✓	✓	✓	
2 5mm 7/32"	KR-A-050-	✓	✓	✓	

C = Countersunk Drilled Suggested screws: Phillips No. 4, length 1"

### KR-B

Retrofit ramp profile for resilient floor coverings such as LVT, LVP and sheet vinyl:

- Solid commercial transition to adjacent lower flooring
- Installed using adhesive
- Ridged surface

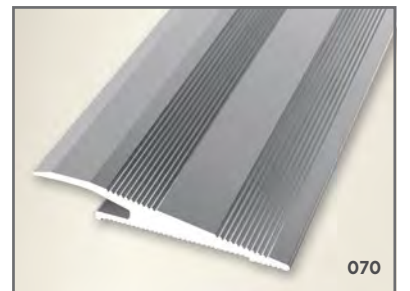
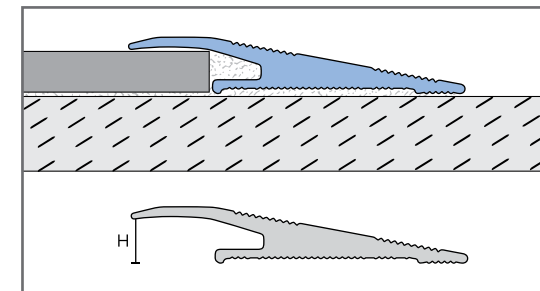
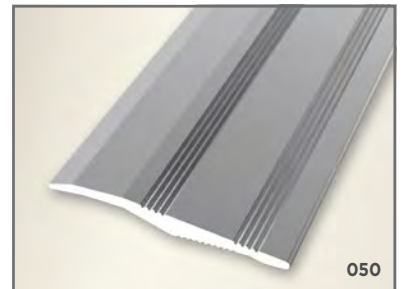
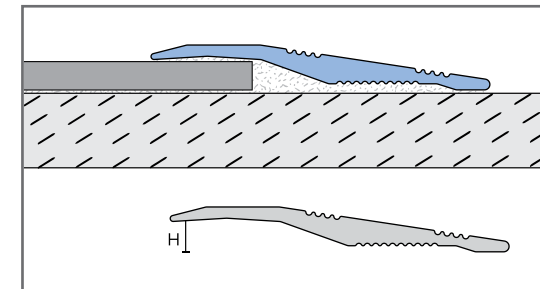

KR-B			A1	A2	A3
Length 2.50m = 8' 2-1/2"	Product Code	Anodized Aluminum Silver \$/Length	Anodized Aluminum Sand \$/Length	Anodized Aluminum Bronze \$/Length	
H = mm - in.	KR-B-000-	U	U	U	
1 5mm 7/32"	KR-B-050-	✓	✓	✓	
2 7mm 9/32"	KR-B-070-	✓	✓	✓	

U = Unpunched/Solid  
**KR-B-050-** For flooring between (2.5-5mm) 3/32-7/32"  
**KR-B-070-** For flooring between (5-7mm) 7/32-9/32"

# KÜBERIT RAMP PROFILES

## KR-C

Retrofit ramp profile for resilient floor coverings such as LVT, LVP and sheet vinyl and laminate:

- Transition to lower adjacent flooring
- Installed using self-stick
- Ridged surface

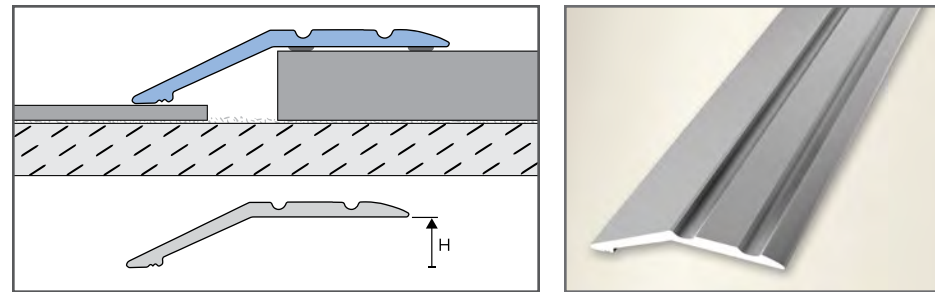

KR-C		A1	A2	A3	A4
Anodized Aluminum		Silver \$/Length	Sand \$/Length	Bronze \$/Length	Black \$/Length
2.50m = 8' 2-1/2"		KR-C-000-	S	S	S
1	4mm 5/32"	KR-C-040-	✓	✓	* ✓
2	8mm 5/16"	KR-C-080-	✓	✓	* ✓

S = Self-Stick \* Also available in white

## KR-D

Retrofit ramp profile for resilient floor coverings such as LVT, LVP and sheet vinyl and laminate:

- Transition to lower adjacent flooring
- Variable for flooring height of (2mm to 18mm) 1/16" to 11/16"
- Installed using self-stick
- Smooth surface

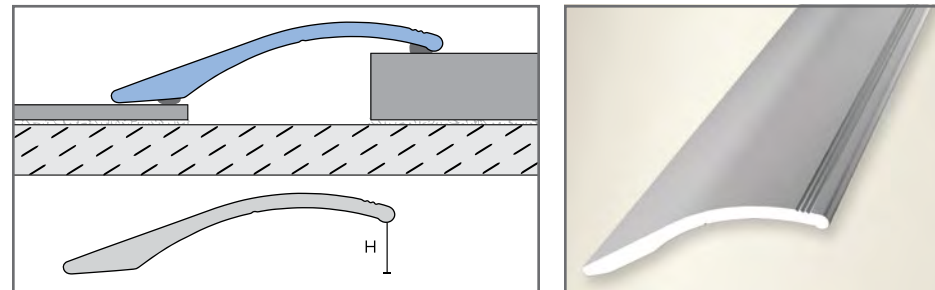

KR-D		A1	A2	A3	A4
Anodized Aluminum		Silver \$/Length	Sand \$/Length	Bronze \$/Length	Black \$/Length
2.50m = 8' 2-1/2"		KR-D-000-	S	S	S
1	18mm 11/16"	KR-D-180-	✓	✓	* ✓

S = Self-Stick \* Also available in white

## KR-E

Retrofit ramp profile for installation of wood, laminate or ceramic floor coverings:

- Transition to lower adjacent flooring
- Heavy duty transition from (8.5mm to 15mm) 5/16" to 9/16" to lower adjacent floorings
- Installed using screws
- Ridged surface

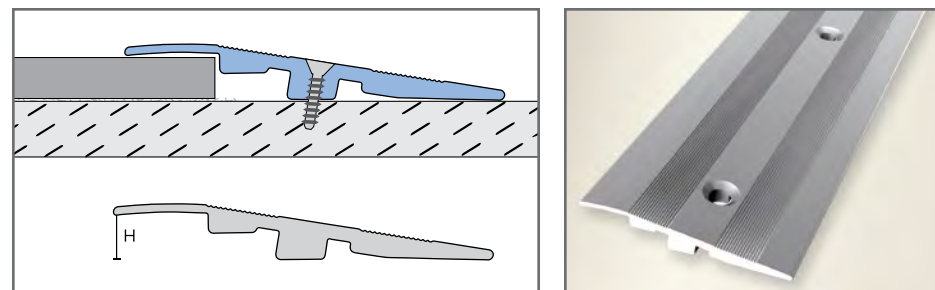

KR-E		AN	A1
Length 2.50m = 8' 2-1/2"	Product Code	Aluminum Natural \$/Length	Anodized Aluminum Silver \$/Length
H = mm - in.	KR-E-000-	C	C
1 15mm 9/16"	KR-E-150-	✓	* ✓

C = Countersunk Drilled - Screws included

# KÜBERIT RAMP PROFILES

## KR-F

Pre-fit ramp profile for wood and laminate floor coverings:

- Transition to lower adjacent flooring
- Heavy duty
- Ready-made 90° exterior corners available (EC)
- Installed prior to placing floor covering using adhesive
- Smooth surface
- Profiles KR-F-090, KR-F-100 are ADA Compliant

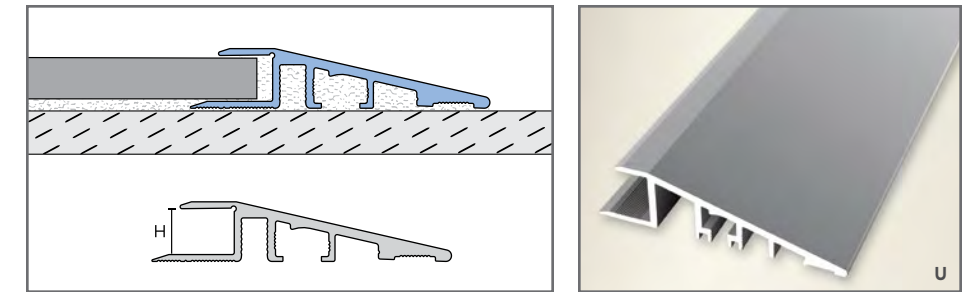
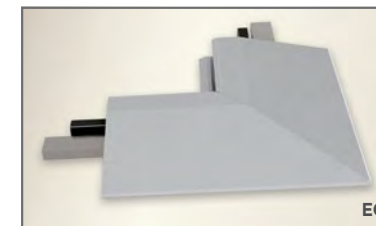

KR-F		A1
Length 2.50m = 8' 2-1/2"	Product Code	Anodized Aluminum Silver \$/Length
H = mm - in.	KR-F-000-	U EC
1 9mm 11/32"	KR-F-090-	✓ ✓
2 10mm 3/8"	KR-F-100-	✓ ✓
3 15mm 9/16"	KR-F-150-	✓ ✓
4 20mm 13/16"	KR-F-200-	✓ ✓
5 22mm 7/8"	KR-F-220-	✓ ✓

U = Unpunched/Solid EC = Exterior Corner

## KR-G

Pre-fit ramp profile for ceramic floor coverings:

- Transition between ceramic tiles to lower adjacent floor coverings
- Heavy duty
- Installed prior to placing floor covering using adhesive
- Ridged surface

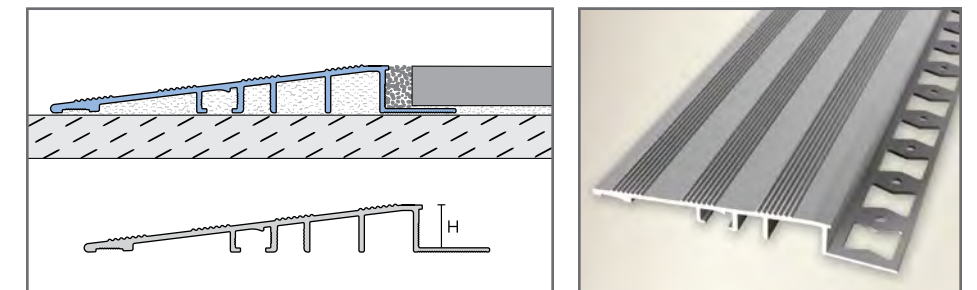

KR-G		AN	A1
Length 2.50m = 8' 2-1/2"	Product Code	Aluminum Natural \$/Length	Anodized Aluminum Silver \$/Length
H = mm - in.	KR-G-000-	P	P
1 10mm 3/8"	KR-G-100-	✓	✓
2 12.5mm 1/2"	KR-G-125-	✓	✓

P = Punched/Perforated

# KÜBERIT RAMP PROFILES

## KR-H

Pre-fit ramp profile for ceramic floor coverings:

- Transition between ceramic tiles to lower adjacent carpets or resilient flooring
- Installed prior to placing floor covering using adhesive
- Smooth surface

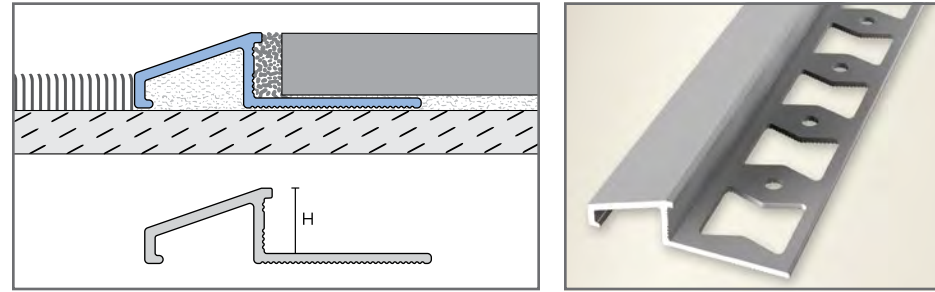

KR-H		A1	SP
Length 2.50m = 8' 2-1/2"	Product Code	Anodized Aluminum Silver \$/Length	Stainless Steel Polished \$/Length
H = mm - in.	KR-H-000-	P	P
1 8mm 5/16"	KR-H-080-	✓	✓
2 10mm 3/8"	KR-H-100-	✓	✓
3 12.5mm 1/2"	KR-H-125-	✓	✓

P = Punched/Perforated

## KR-I

Pre-fit ramp profile for ceramic floor coverings:

- Transition between ceramic tiles to lower adjacent floor coverings
- Installed prior to placing floor covering using adhesive
- Smooth surface

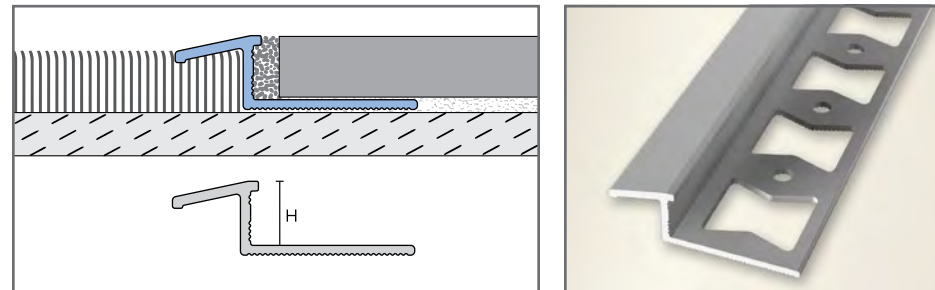

KR-I		AN	A1	A2	A3
Length 2.50m = 8' 2-1/2"	Product Code	Aluminum Natural \$/Length	Anodized Aluminum Silver \$/Length	Anodized Aluminum Sand \$/Length	Anodized Aluminum Bronze \$/Length
H = mm - in.	KR-I-000-	P	P	P	P
1 8mm 5/16"	KR-I-080-	✓	✓	✓	✓
2 10mm 3/8"	KR-I-100-	✓	✓	✓	✓
3 12.5mm 1/2"	KR-I-125-	✓	✓	✓	✓

P = Punched/Perforated

# KÜBERIT RAMP PROFILES

## KR-J

Pre-fit ramp profile for resilient floor coverings such as LVT, LVP and sheet vinyl:

- Solid commercial transition to adjacent lower flooring
- Installed prior to placing floor covering using adhesive
- Smooth surface

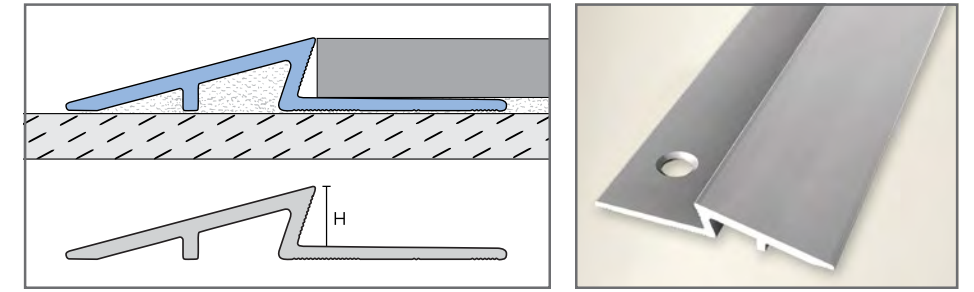

KR-J		A1
Length 2.50m = 8' 2-1/2"	Product Code	Anodized Aluminum Silver \$/Length
H = mm - in.	KR-J-000-	C
1 6mm 1/4"	KR-J-060-	✓







C = Countersunk Drilled





## KÜBERIT STAIR-NOSING PROFILES

We offer a large selection of decorative stair-nosings for new or retrofit installations. Proper application of stair-nosing protects the floor covering in place and provides safety protection by increasing visibility and slip resistance.

-  Resilient
-  Laminate
-  Wood
-  Ceramic
-  Natural Stone
-  Carpet

**STEP UP THE SOPHISTICATION**  
...WITH KÜBERIT PROFILES.

# KÜBERIT STAIR-NOSING PROFILES

## KS-A

Pre-fit stair step edge protection for resilient floor coverings such as LVT, LVP and sheet vinyl and laminate:

- Pre-determined bending point to adjust the nosing to the stairs
- Installed prior to placing floor covering using adhesive or screws
- Can be used on walls
- Smooth surface

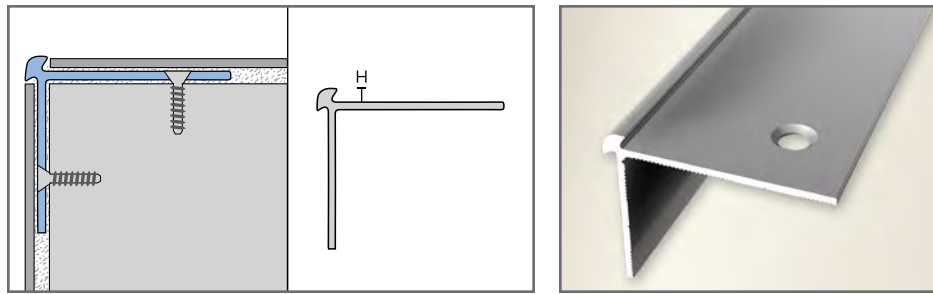

KS-A		A1	A2	A3	A4
Length 2.50m = 8' 2-1/2"	Product Code	Silver \$/Length	Sand \$/Length	Bronze \$/Length	Black \$/Length
H = mm - in.	KS-A-000-	C	C	C	C
1 3mm 1/8"	KS-A-030-	✓	✓	✓	✓
2 4mm 5/32"	KS-A-040-	✓	✓	✓	
3 5mm 7/32"	KS-A-050-	✓	✓	✓	
4 6mm 1/4"	KS-A-060-	✓	✓	✓	
5 8mm 5/16"	KS-A-080-	✓	✓	✓	

C = Countersunk Drilled Suggested screws: Phillips No. 4, length 1"

## KS-B

Pre-fit stair step edge protection for resilient floor coverings such as LVT, LVP and sheet vinyl:

- Installed prior to placing floor covering using adhesive or screws
- Smooth surface

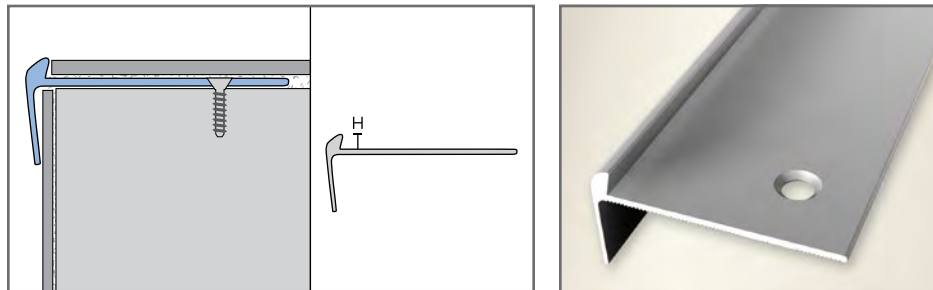

KS-B		A1	A2	A3
Length 2.50m = 8' 2-1/2"	Product Code	Anodized Aluminum Silver \$/Length	Anodized Aluminum Sand \$/Length	Anodized Aluminum Bronze \$/Length
H = mm - in.	KS-B-000-	C	C	C
1 3mm 1/8"	KS-B-030-	✓	✓	✓
2 5mm 7/32"	KS-B-050-	✓	✓	✓
3 6mm 1/4"	KS-B-060-	✓	✓	✓

C = Countersunk Drilled Suggested screws: Phillips No. 4, length 1"

# KÜBERIT STAIR-NOSING PROFILES

## KS-C

Pre-fit stair step edge protection for resilient floor coverings such as LVT, LVP and sheet vinyl:

- Bull-nose for round wood step edges
- Installed prior to placing floor covering using adhesive or screws
- Smooth surface

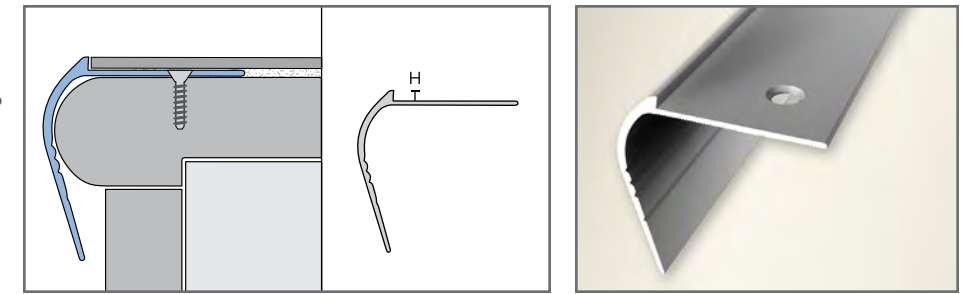
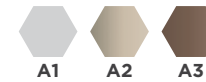

KS-C		A1	A2	A3
Length 2.50m = 8' 2-1/2"	Product Code	Anodized Aluminum Silver \$/Length	Anodized Aluminum Sand \$/Length	Anodized Aluminum Bronze \$/Length
H = mm - in.	KS-C-000-	C	C	C
1 3mm 1/8"	KS-C-030-	✓	✓	✓
2 5mm 7/32"	KS-C-050-	✓	✓	✓

C = Countersunk Drilled Suggested screws: Phillips No. 4, length 1"

## KS-D

Pre-fit stair step edge protection for resilient floor coverings such as LVT, LVP and sheet vinyl, laminate and wood:

- Installed prior to placing floor covering using adhesive or screws
- Ridged surface

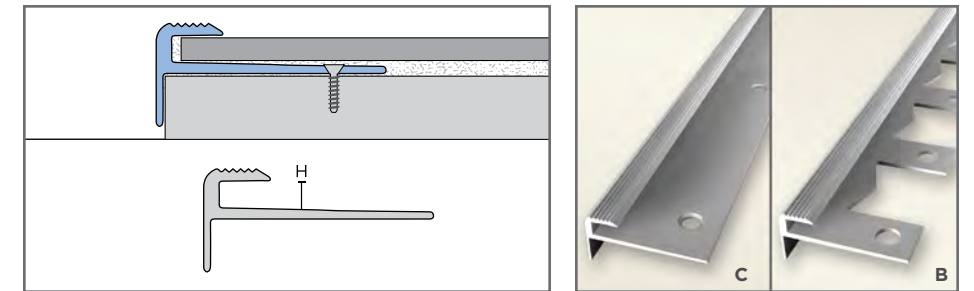

KS-D		A1	A2	A3
Length 2.50m = 8' 2-1/2"	Product Code	Anodized Aluminum Silver \$/Length	Anodized Aluminum Sand \$/Length	Anodized Aluminum Bronze \$/Length
H = mm - in.	KS-D-000-	C	B	C
1 3mm 1/8"	KS-D-030-	✓	✓	✓
2 5mm 7/32"	KS-D-050-	✓	✓	✓
3 8mm 5/16"	KS-D-080-	✓	✓	✓
4 10mm 3/8"	KS-D-100-	✓	✓	✓
5 12.5mm 1/2"	KS-D-125-	✓	✓	✓
6 15mm 9/16"	KS-D-150-	✓	✓	✓

C = Countersunk Drilled B = Bendable Suggested screws: Phillips No. 4, length 1"

## KÜBERIT STAIR-NOSING PROFILES

### KS-E

Pre-fit stair step edge protection for resilient floor coverings such as LVT, LVP and sheet vinyl, laminate and wood:

- For flooring tread and riser to be installed into the profile
- Installed prior to placing floor covering using adhesive or screws
- Ridged surface

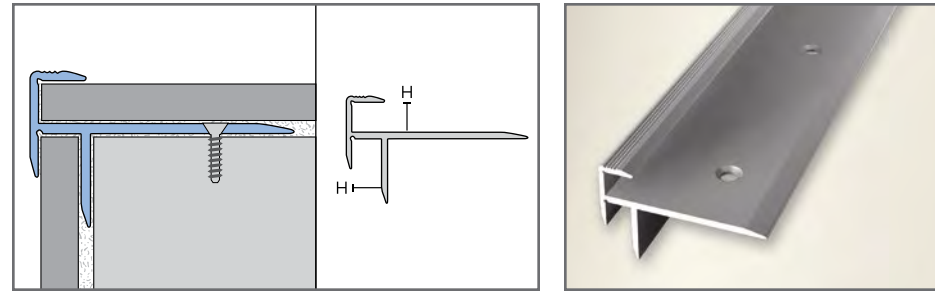
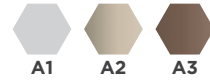

KS-E		A1	A2	A3
Length 2.50m = 8' 2-1/2"	Product Code	Anodized Aluminum Silver \$/Length	Anodized Aluminum Sand \$/Length	Anodized Aluminum Bronze \$/Length
H = mm - in.	KS-E-000-	C	C	C
1 5mm 7/32"	KS-E-050-	✓	✓	✓
2 8mm 5/16"	KS-E-080-	✓	✓	✓
3 10mm 3/8"	KS-E-100-	✓	✓	✓
4 12.5mm 1/2"	KS-E-125-	✓	✓	✓
5 15mm 9/16"	KS-E-150-	✓	✓	✓

C = Countersunk Drilled Suggested screws: Phillips No. 4, length 1"

### KS-F

Retrofit stair step edge protection for all types of floor coverings:

- Heavy duty
- Sloped edge
- Slip-resistant PVC insert is available in many colors
- Installed using adhesive or screws
- Ridged surface

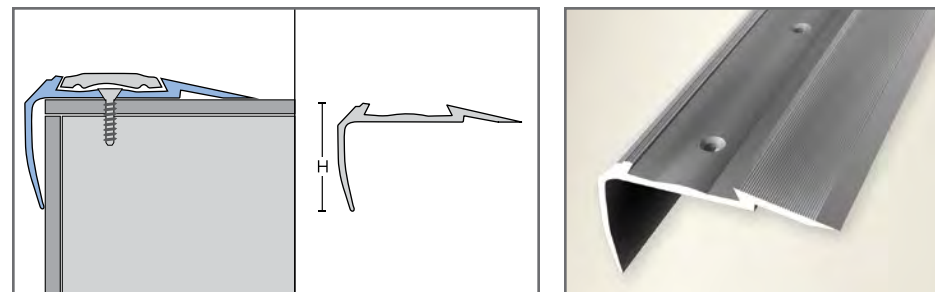

KS-F		A1	A2	A3
Length 2.50m = 8' 2-1/2"	Product Code	Anodized Aluminum Silver \$/Length	Anodized Aluminum Sand \$/Length	Anodized Aluminum Bronze \$/Length
H = mm - in.	KS-F-000-	C	C	C
1 30mm 1-3/16"	KS-F-300-	✓		
2 50mm 1-31/32"	KS-F-500-	✓	✓	✓

C = Countersunk Drilled Suggested screws: Phillips No. 6, length 1-3/16"  
PVC insert must be ordered separately. Please refer to page 31.

## KÜBERIT STAIR-NOSING PROFILES

### KS-G

Retrofit stair step edge protection for all types of floor coverings:

- Heavy duty stair-nosing profile
- Bull-nose for round wood step edges
- Sloped edge
- Slip-resistant PVC insert is available in many colors
- Installed using adhesive or screws
- Smooth surface

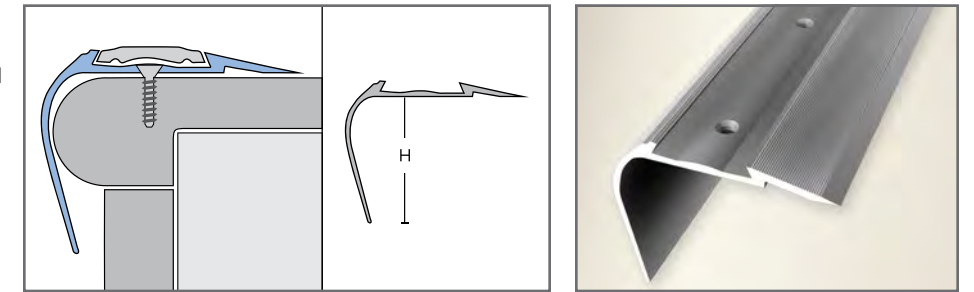

KS-G		A1
Length 2.50m = 8' 2-1/2"	Product Code	Anodized Aluminum Silver \$/Length
H = mm - in.	KS-G-000-	C
1 44mm 1-3/4"	KS-G-440-	✓

C = Countersunk Drilled Suggested screws: Phillips No. 6, length 1-3/16"  
PVC insert must be ordered separately. Please refer to page 31.

### KS-H

Retrofit stair step edge protection for resilient floor coverings such as LVT, LVP and sheet vinyl:

- Heavy duty stair-nosing profile
- Flush installation with floorings from (4-5mm) 5/32-3/16"
- Slip-resistant PVC insert is available in many colors
- Installed using adhesive or screws
- Smooth surface

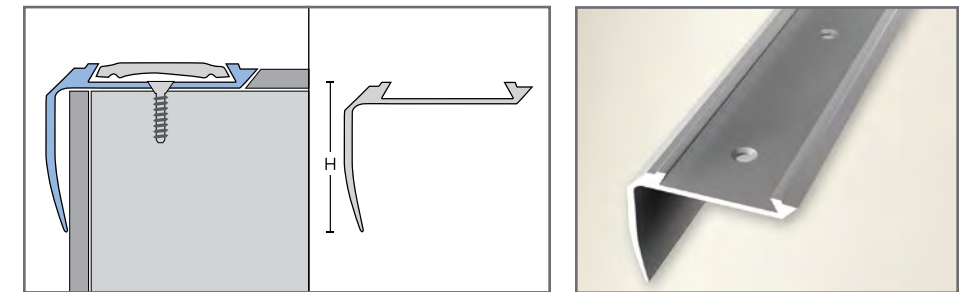

KS-H		A1	X1
Length 2.50m = 8' 2-1/2"	Product Code	Anodized Aluminum Silver \$/Length	Brass \$/Length
H = mm - in.	KS-H-000-	C	C
1 34mm 1-11/32"	KS-H-340-	✓	✓
2 46mm 1-13/16"	KS-H-460-	✓	

C = Countersunk Drilled Suggested screws: Phillips No. 6, length 1-3/16"  
PVC inserts must be ordered separately. Please refer to page 31.

# KÜBERIT STAIR-NOSING PROFILES

## KS-I

Retrofit stair step edge protection for resilient floor coverings such as LVT, LVP and sheet vinyl:

- Heavy duty stair-nosing profile
- Flush installation with floorings from (4-5mm) 5/32-3/16"
- Installed using adhesive or screws
- Extra wide slip resistant surface for 2 PVC inserts
- PVC inserts are available in many colors
- Smooth surface

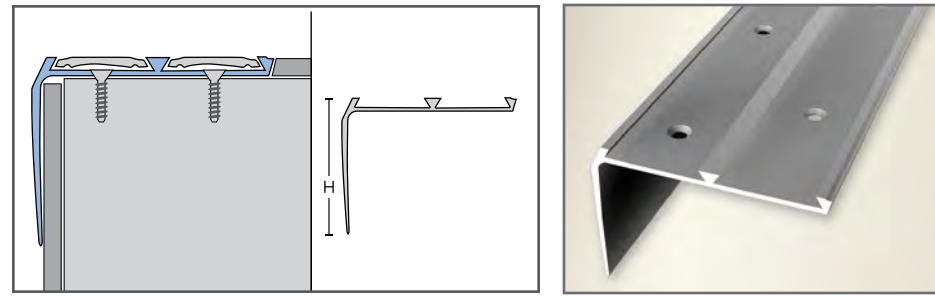

KS-I		A1	
Length 2.50m = 8' 2-1/2"	Product Code	Anodized Aluminum Silver \$/Length	
H = mm - in.	KS-I-000-	C	
1 46mm 1-13/16"	KS-I-460-	✓	

C = Countersunk Drilled Suggested screws: Phillips No. 6, length 1-3/16"  
PVC inserts must be ordered separately. Please refer to page 31.

## KS-J

Retrofit stair step protection with adjustable edge for resilient floor coverings such as LVT, LVP and sheet vinyl as well as carpets:

- Heavy duty stair-nosing profile
- Installed using adhesive or screws
- Extra-wide slip resistant surface
- PVC insert is available in many colors
- Smooth surface

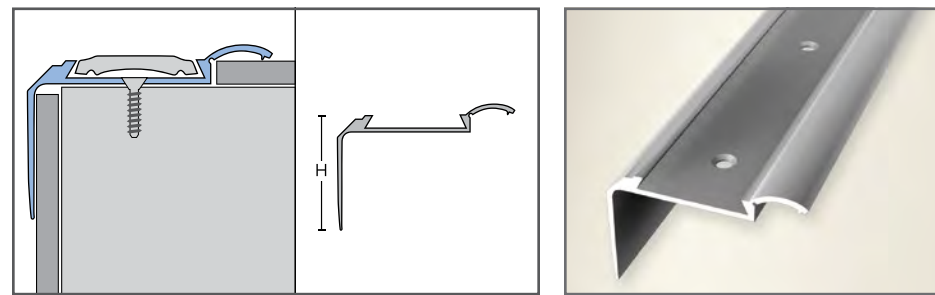

KS-J		A1	
Length 2.50m = 8' 2-1/2"	Product Code	Anodized Aluminum Silver \$/Length	
H = mm - in.	KS-J-000-	C	
1 33mm 1-5/16"	KS-J-330-	✓	

C = Countersunk Drilled Suggested screws: Phillips No. 6, length 1-3/16"  
PVC insert must be ordered separately. Please refer to page 31.

## KS-K

Retrofit stair step edge protection for all types of floor coverings:

- Heavy duty stair-nosing profile
- Deeply ridged for slip resistance
- Installed using adhesive

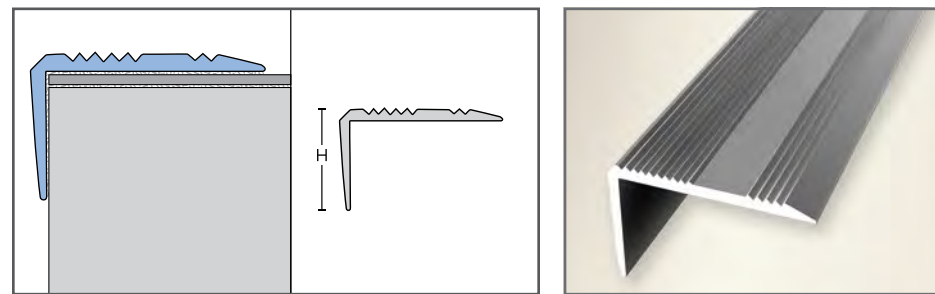
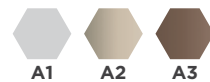

KS-K		A1	A2	A3
Length 2.50m = 8' 2-1/2"	Product Code	Anodized Aluminum Silver \$/Length	Anodized Aluminum Sand \$/Length	Anodized Aluminum Bronze \$/Length
H = mm - in.	KS-K-000-	U	U	U
1 23mm 29/32"	KS-K-230-	✓	✓	✓
2 55mm 2-3/16"	KS-K-550-	✓	✓	✓

U = Unpunched/Solid

# KÜBERIT STAIR-NOSING PROFILES

## KS-L

Pre-fit stair step edge protection for ceramic floor coverings:

- Heavy duty stair-nosing profile
- Installed prior to placing floor covering using adhesive
- Ridged surface

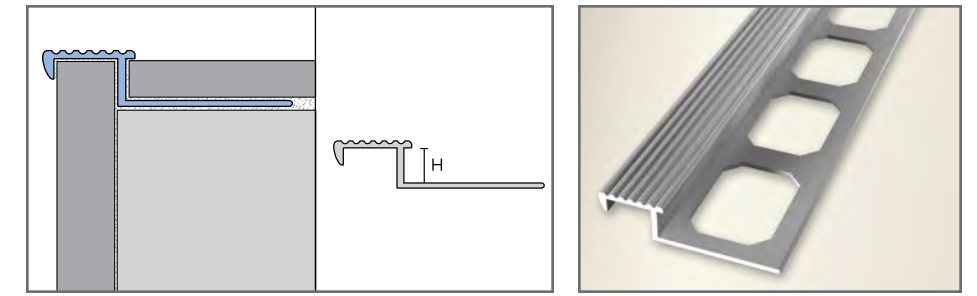

KS-L		AN		A1	
Length 2.50m = 8' 2-1/2"	Product Code	Aluminum Natural \$/Length		Anodized Aluminum Silver \$/Length	
H = mm - in.	KS-L-000-	P		P	
1 9mm 11/32"	KS-L-090-	✓		✓	
2 11mm 7/16"	KS-L-110-	✓		✓	

P = Punched/Perforated

## KS-PVC

PVC Inserts for safety stair-nosings

- Inserts are exchangeable
- Use with appropriate adhesive
- Use at room temperature to facilitate insertion
- Ridged and Smooth versions are available in all nine color options

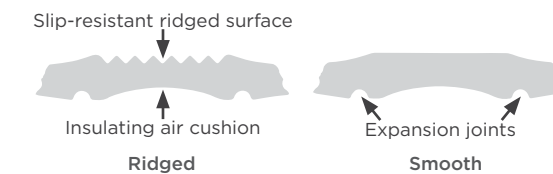

PVC Inserts		1	2	3	4	5	6	7	8	9	10
Length (1 Roll) 25m = 82'	Product Code	Black	Brown	Anthracite	Light Grey	Beige Grey	Beige	Blue	Red	Fluorescent	Yellow
\$/Roll	KS-PVC-	R	S	R	S	R	S	R	S	R	S
1	\$80.75	KS-PVC-	✓	✓	✓	✓	✓	✓	✓	✓	✓

R = Ridged Insert S = Smooth Insert  
To order Küberit PVC Inserts: Item No. = Product code-Color-Version (e.g. Smooth Red Insert = KS-PVC-8-S)





## KÜBERIT CLIP SYSTEM PROFILES

DESIGN-CLIP profiles are uniquely designed for floating flooring systems. It's two-part profile system with a smooth surface allows for a (6mm) 1/4" expansion. Professional installers can install the profile quickly and easily, due to the user-friendly click technology and extremely solid click connection. Design-Clip is a suitable transition for resilient floor coverings and carpets of different heights, as well as same-level transitions and edge trim.

MONO-CLIP profiles are especially designed for all hard flooring options from (7-22mm) 9/32-7/8". A two-part profile system with three different base options allows for a (13mm) 1/2" expansion. Paired with new friction-locked technology, it makes for a more convenient, faster and safer installation. The smooth surface and slender design with no visible screws are sure to impress.

- Resilient
- Laminate
- Wood
- Ceramic
- Natural Stone
- Carpet

### MAKE THE CONNECTION ...WITH KÜBERIT PROFILES.

NOTE: Color representation will vary between our catalog, website, printouts and monitor displays. These cannot technically represent the true color of the materials and the different finishes/colors. Please feel free to order samples of materials and colors from us.

## KÜBERIT CLIP SYSTEM PROFILES

### KC-D

Design-Clip - For installation of all types of floor coverings:

- All Design-Clips consist of two parts: Three different tops fit one standard base
- Bases and tops are made of aluminum and have an extremely solid connection
- For resilient floor coverings (4-7.5 mm) 5/32-9/32" or carpet (5-12mm) 7/32-15/32"
- Installed using the fastening hardware included, can also be secured with appropriate adhesive
- Available as Reducer, Edge Trim and Transition
- Various wood options available
- Smooth surface
- Different lengths available upon request, please allow for extra delivery time

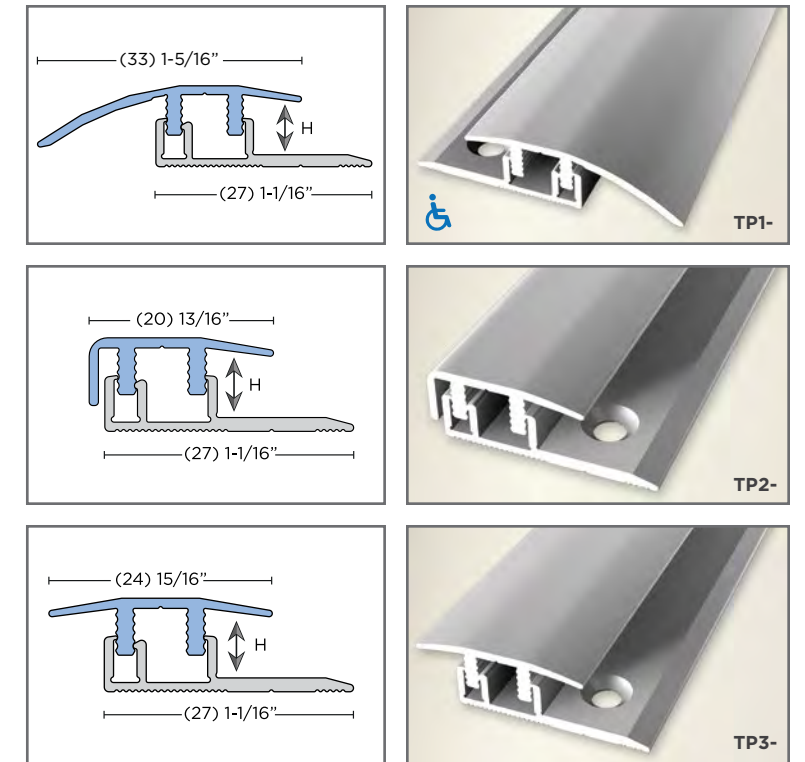
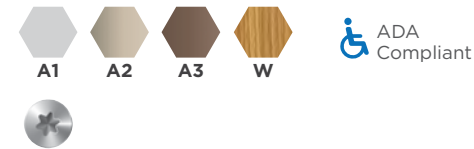

KC-D		A1	A2	A3	W*	NOTE:
Length	Product Code	Anodized Aluminum Silver \$/Length	Anodized Aluminum Sand \$/Length	Anodized Aluminum Bronze \$/Length	Wood Decor \$/Length	Each profile comes with matching base that is countersunk drilled
2.50m = 8' 2-1/2"						
H = mm - in.	KC-D-000-	U	U	U	W1-7	
1 4-12 mm 5/32"-15/32"	KC-D-TP1-	✓	✓	✓	✓	Reducer
2 4-12 mm 5/32"-15/32"	KC-D-TP2-	✓	✓	✓	✓	Edge Trim
3 4-12 mm 5/32"-15/32"	KC-D-TP3-	✓	✓	✓	✓	Transition

Base Profile Set - Screws included. Tops: U = Unpunched/Solid Bases: C = Countersunk Drilled  
\*W: For Wood Decor options, please refer to page 5.



- 1) Screw or anchor the BASE profile (plug mounting). In case of underfloor heating, fasten the profile by using a two-component adhesive.
- 2) Lay the floor covering and pay attention to the expansion joint as recommended by the flooring manufacturer.
- 3) Place the TOP profile carefully on the BASE profile, first bringing it into the correct position.
- 4) Adjust height differences with well controlled hammer blows (using a block of hardwood with felt).
- 5) The high-quality installation is finished!

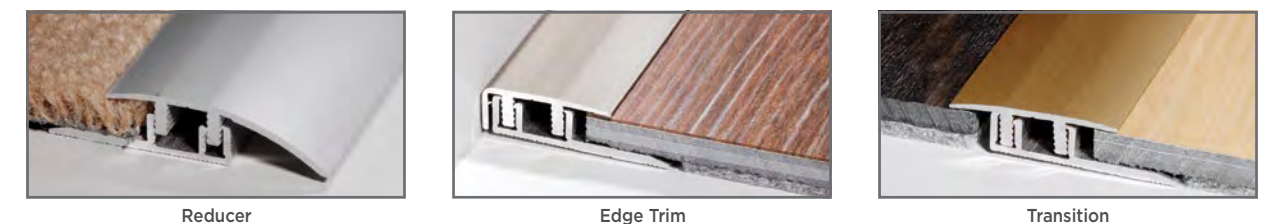

# KÜBERIT CLIP SYSTEM PROFILES

## KC-M

**Mono-Clip – For installation of all types of floor coverings:**

- All Mono-Clips consist of two parts: Three different tops and three different bases can be combined (Please order separately)
- Bases and tops are made of aluminum and have an extremely solid connection
- Countersunk drilled base to be installed using screws or adhesive
- Top profile to be clicked into base
- Additional finishes
- Various wood options available
- Smooth surface
- Different lengths available upon request, please allow for extra delivery time
- KC-M-TP1 is ADA compliant up to 9mm

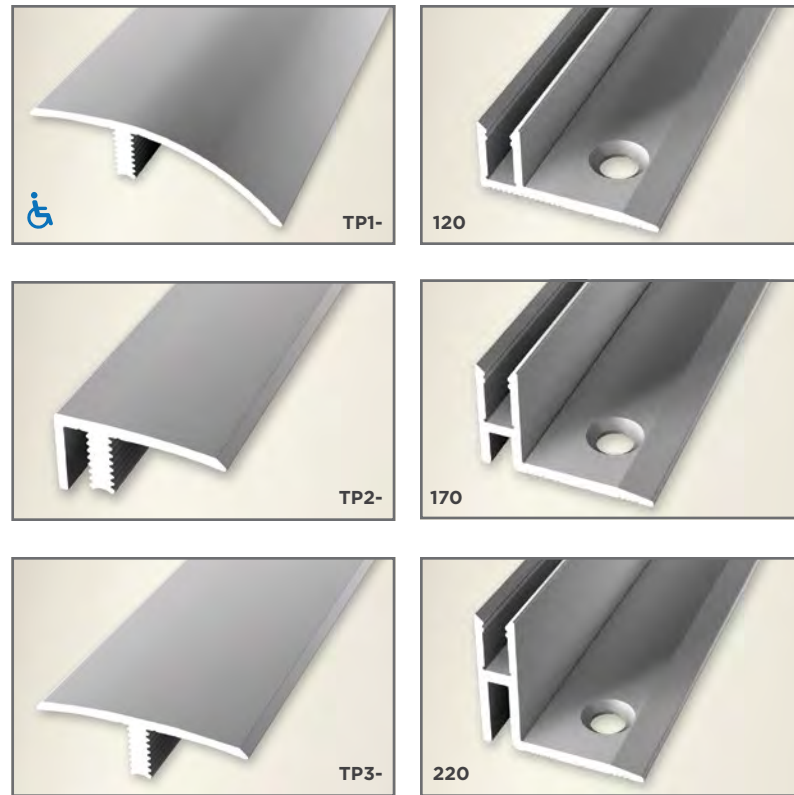
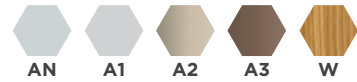

KC-M		AN	A1	A2	A3	W*	NOTE: Please order top and base separately
Length 2.50m = 8' 2-1/2"	Product Code	Aluminum Natural \$/Length	Anodized Aluminum Silver \$/Length	Anodized Aluminum Sand \$/Length	Anodized Aluminum Bronze \$/Length	Wood Decor \$/Length	
H = mm - in.	KC-M-000-	C	U	U	U	U	
1 7-22 mm 9/32" - 7/8"	KC-M-TP1-		✓	✓	✓	✓	Reducer
2 7-22 mm 9/32" - 7/8"	KC-M-TP2-		✓	✓	✓	✓	Edge Trim
3 7-22 mm 9/32" - 7/8"	KC-M-TP3-		✓	✓	✓	✓	Transition
4 7-12 mm 9/32" - 15/32"	KC-M-120-	✓					Mono-Clip Base
5 12-17 mm 15/32" - 21/32"	KC-M-170-	✓					Mono-Clip Base
6 17-22 mm 21/32" - 7/8"	KC-M-220-	✓					Mono-Clip Base

Tops: U = Unpunched/Solid \*W: For Wood Decor options, please refer to page 5.  
Bases: C = Countersunk Drilled (Available in Aluminum Natural finish) Suggested screws: Phillips No. 6, length 1-3/16"

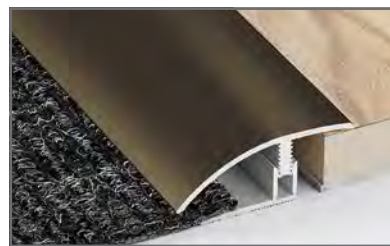

Reducer



Edge Trim



Transition

# KÜBERIT CLIP SYSTEM PROFILES

Mono-Clip: 3 Base Profile Sizes

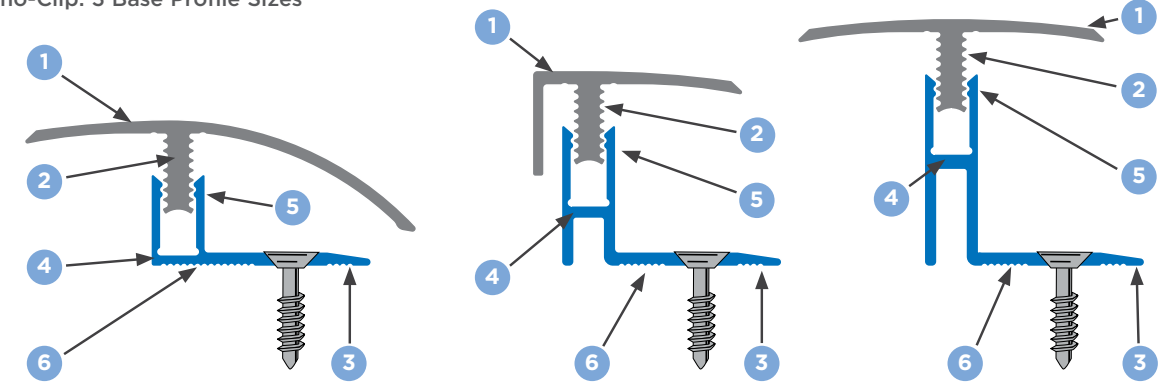

Top Profile KC-M-TP1	Top Profile KC-M-TP2	Top Profile KC-M-TP3
Shown with Base Profile KC-M-120	Shown with Base Profile KC-M-170	Shown with Base Profile KC-M-220



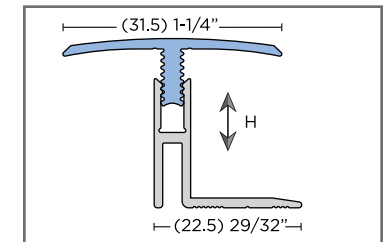
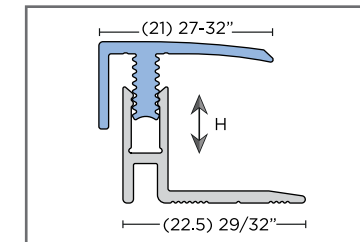
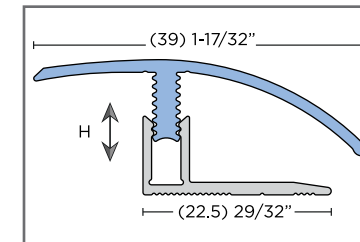



- 1) Top profile (3 options)
- 2) Positive-engagement guide strip
- 3) Base profile (3 sizes), fastening with screws, anchor alongside the subfloor joint
- 4) Predetermined bending point
- 5) Counter edge with 2-point-interlock system
- 6) Ridged for applying adhesive (for underfloor heating)





## KÜBERIT WALL PROTECTION PROFILES

These decorative profile options make it much easier to install wall coverings from edge to edge, add an extra design element for tile installations, and also provide solid corner protection.

-  Resilient
-  Laminate
-  Wood
-  Ceramic
-  Natural Stone
-  Carpet

**PROTECT AGAINST LIFE'S  
BUMPS AND BRUISES**  
...WITH KÜBERIT PROFILES.

NOTE: Color representation will vary between our catalog, website, printouts and monitor displays. These cannot technically represent the true color of the materials and the different finishes/colors. Please feel free to order samples of materials and colors from us.

# KÜBERIT WALL PROTECTION PROFILES

## KW-A

Pre-fit interior corner for wall protection:

- Can be used for resilient floor coverings
- Can be used on staircases
- Installed using screws, nails or adhesive
- Smooth surface

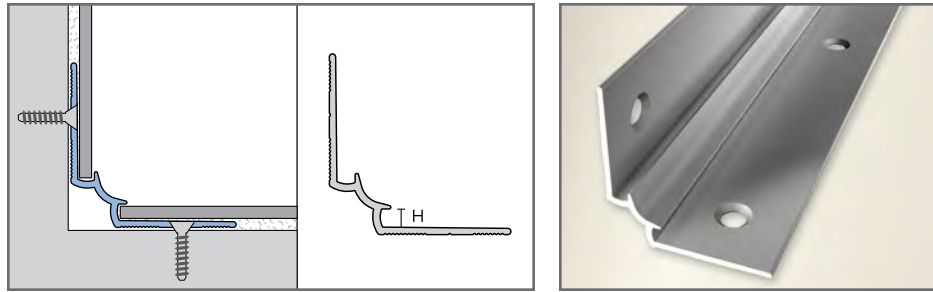
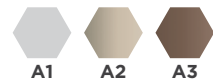

KW-A		A1	A2	A3
Length 2.50m = 8' 2-1/2"	Product Code	Anodized Aluminum Silver \$/Length	Anodized Aluminum Sand \$/Length	Anodized Aluminum Bronze \$/Length
H = mm - in.	KW-A-000-	C	C	C
1 3mm 1/8"	KW-A-030-	✓	✓	✓

C = Countersunk Drilled Suggested screws: Phillips No. 4, length 1"

## KW-B

Pre-fit interior corner for wall protection:

- Can be used as a baseboard trim for resilient floor coverings
- Can be used on staircases
- Installed using screws, nails or adhesive
- Smooth surface

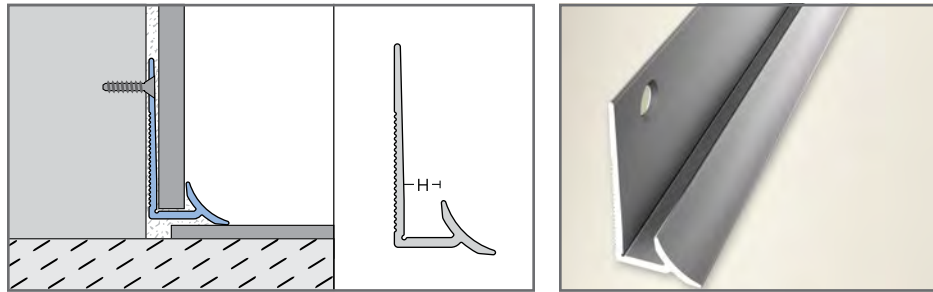
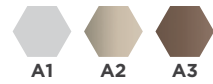

KW-B		A1	A2	A3
Length 2.50m = 8' 2-1/2"	Product Code	Anodized Aluminum Silver \$/Length	Anodized Aluminum Sand \$/Length	Anodized Aluminum Bronze \$/Length
H = mm - in.	KW-B-000-	C	C	C
1 5mm 7/32"	KW-B-050-	✓	✓	✓

C = Countersunk Drilled Suggested screws: Phillips No. 4, length 1"

## KW-C

Pre-fit aluminum skirting for walls:

- Can be used as baseboard trim for wood, laminate and carpet
- Installed using screws, nails or adhesive
- Smooth surface

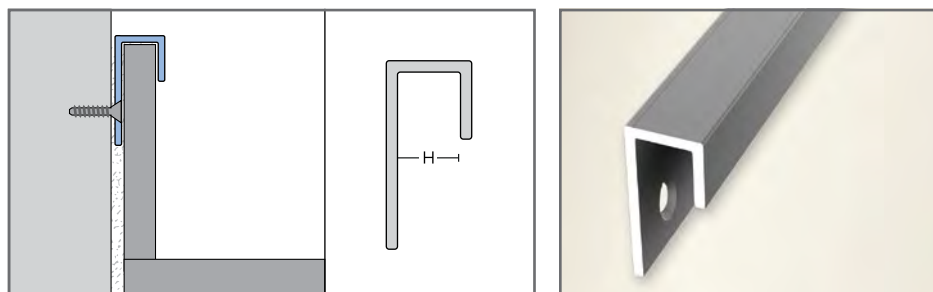

KW-C		A1
Length 2.50m = 8' 2-1/2"	Product Code	Anodized Aluminum Silver \$/Length
H = mm - in.	KW-C-000-	C
1 9mm 11/32"	KW-C-090-	✓

C = Countersunk Drilled Suggested screws: Phillips No. 4, length 1"

# KÜBERIT WALL PROTECTION PROFILES

## KW-D

Retrofit aluminum skirting for walls:

- For floor to ceiling windows and terrace doors with no space for skirting
- Can be used for staircases
- Can also be used as a self-stick baseboard trim for all types of floor coverings
- Additional adhesive may be required, especially on walls
- Installed using self-stick
- Smooth surface

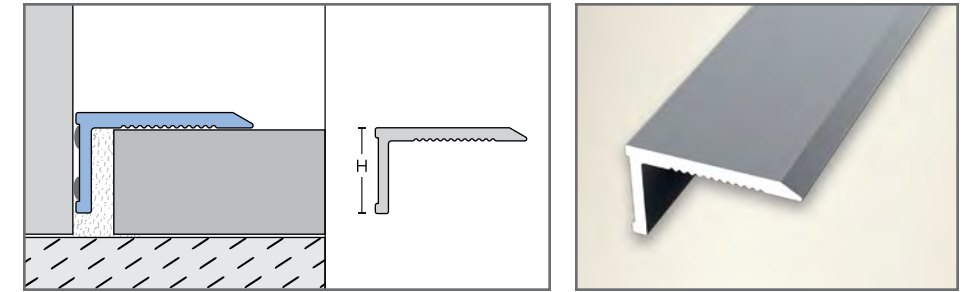
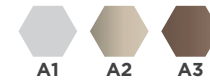

KW-D		A1	A2	A3
Length 2.50m = 8' 2-1/2"	Product Code	Anodized Aluminum Silver \$/Length	Anodized Aluminum Sand \$/Length	Anodized Aluminum Bronze \$/Length
H = mm - in.	KW-D-000-	S	S	S
1 9mm 11/32"	KW-D-090-	✓	✓	✓

S = Self-Stick

## KW-E

Retrofit aluminum skirting for walls:

- For floor to ceiling windows and terrace doors with no space for skirting
- Can also be used as a self-stick baseboard trim for all types of floor coverings
- Double-sided
- Installed using self-stick
- Smooth surface

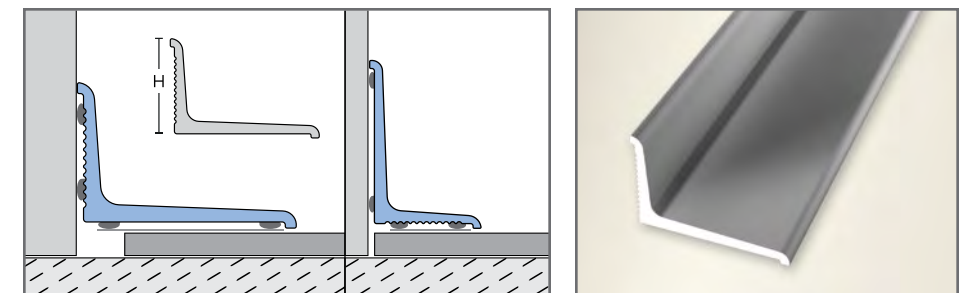

KW-E		A1	A2	A3
Length 2.50m = 8' 2-1/2"	Product Code	Anodized Aluminum Silver \$/Length	Anodized Aluminum Sand \$/Length	Anodized Aluminum Bronze \$/Length
H = mm - in.	KW-E-000-	S	S	S
1 12mm 15/32"	KW-E-120-	✓	✓	✓

S = Self-Stick

## KW-F

Retrofit outer corner guard for walls:

- Install using appropriate adhesive
- Protective film should be removed after installation
- Smooth surface

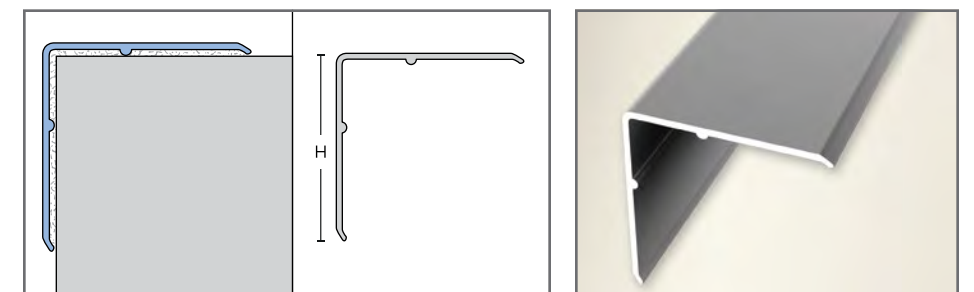

KW-F		AT	SB
Length 2.50m = 8' 2-1/2"	Product Code	Anodized Aluminum Titanium \$/Length	Stainless Steel Brushed \$/Length
H = mm - in.	KW-F-000-	U	U
1 30mm 1-3/16"	KW-F-300-	✓	✓
2 50mm 2"	KW-F-500-	✓	✓

U = Unpunched/Solid

# KÜBERIT WALL PROTECTION PROFILES

## KW-G

Retrofit multi-purpose angle profile:

- Installed using the appropriate adhesive
- Double-sided
- Smooth surface

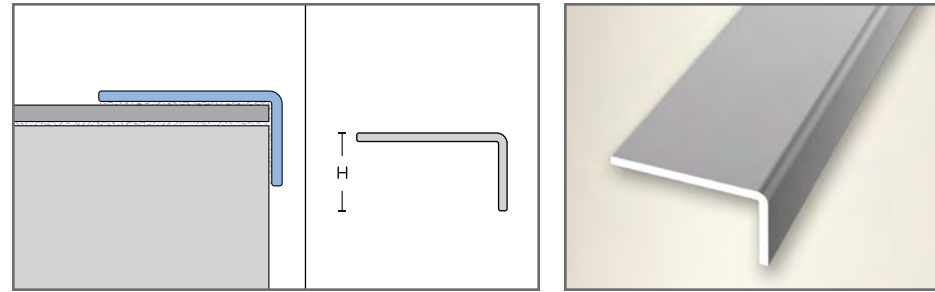
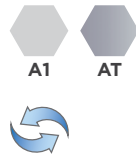

KW-G			A1	AT
Length	2.50m = 8' 2-1/2"	Product Code	Anodized Aluminum Silver \$/Length	Anodized Aluminum Titanium \$/Length
W = mm - in.	KW-G-000-	U	U	U
1 20mm 13/16"	KW-G-200-	✓	✓	✓

U = Unpunched/Solid

## KW-H

Pre-fit exterior corner profile with rounded edge and predetermined bending point for walls:

- Ideal for corners, interior door and window recesses or for separation of larger walls
- For corners that aren't a 90° angle
- Installed using the appropriate adhesive
- Protective film should be removed after installation
- Smooth surface

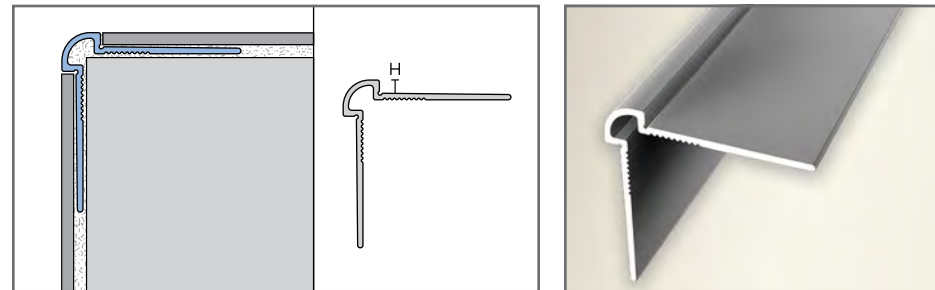

KW-H			A1	AT	A4
Length	2.50m = 8' 2-1/2"	Product Code	Anodized Aluminum Silver \$/Length	Anodized Aluminum Titanium \$/Length	Anodized Aluminum Black \$/Length
H = mm - in.	KW-H-000-	U	U	U	U
1 2mm 1/16"	KW-H-020-	✓	✓	* ✓	

U = Unpunched/Solid For wallpaper and resilient up to (2mm) 1/16" \* Also available in white

## KW-I

Pre-fit interior corner with predetermined bending point for walls:

- For corners that aren't a 90° angle
- Can be used for corners, interior door and window recesses, as well as for accurate separations of larger walls
- Enables neatly cut wallpapers and wall coverings
- Installed using the appropriate adhesive
- Protective film should be removed after installation
- Smooth surface

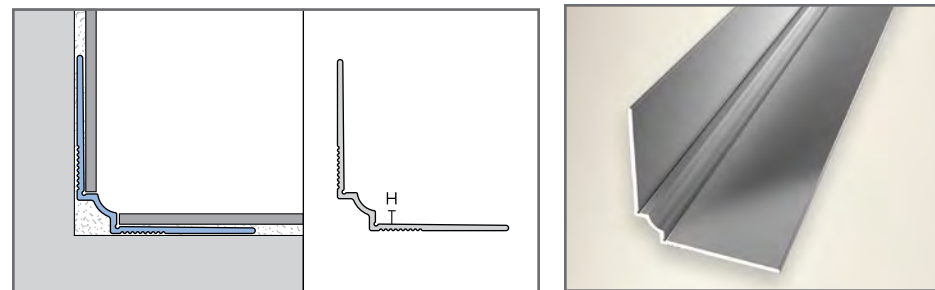

KW-I			A1	AT	A4
Length	2.50m = 8' 2-1/2"	Product Code	Anodized Aluminum Silver \$/Length	Anodized Aluminum Titanium \$/Length	Anodized Aluminum Black \$/Length
H = mm - in.	KW-I-000-	U	U	U	U
1 2mm 1/16"	KW-I-020-	✓	✓	* ✓	

U = Unpunched/Solid For wallpaper and resilient up to (2mm) 1/16" \* Also available in white

# KÜBERIT WALL PROTECTION PROFILES

## KW-J

Pre-fit exterior corner for wall protection:

- Two-part system for wall coverings from (3-5mm) 1/8-7/32"
- Unpunched base to be installed using adhesive
- Top profile to be clicked into base
- Smooth surface

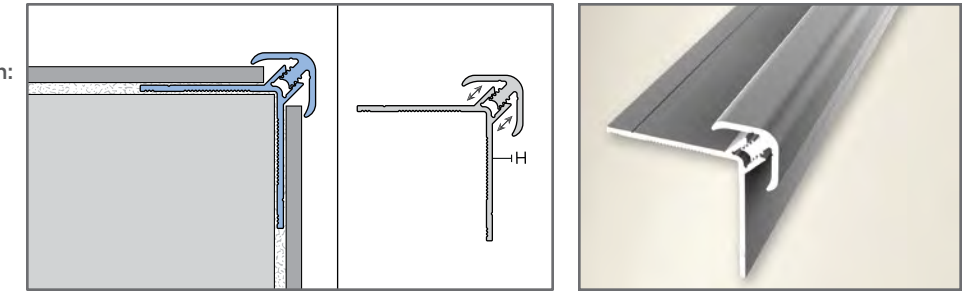

KW-J			A1	AP
Length	2.50m = 8' 2-1/2"	Product Code	Anodized Aluminum Silver \$/Length	Anodized Aluminum Polished \$/Length
H = mm - in.	KW-J-000-	U	U	U
1 3-5mm 1/8" - 7/32"	KW-J-050-	✓	✓	✓

Base and top profile set.  
Tops: U = Unpunched/Solid Bases: U = Unpunched/Solid  
Variable exterior wall corner with four gauges from (3-5mm) 1/8-7/32"

## KW-K

Pre-fit interior corner for wall protection:

- Two-part system for wall coverings from (3-5mm) 1/8-7/32"
- Unpunched base to be installed using adhesive
- Top profile to be clicked into base
- Smooth surface

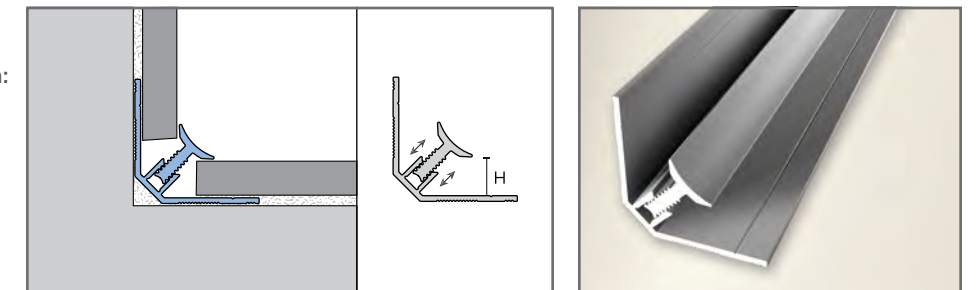

KW-K			A1	AP
Length	2.50m = 8' 2-1/2"	Product Code	Anodized Aluminum Silver \$/Length	Anodized Aluminum Polished \$/Length
H = mm - in.	KW-K-000-	U	U	U
1 3-5mm 1/8" - 7/32"	KW-K-050-	✓	✓	✓

Base and top profile set.  
Tops: U = Unpunched/Solid Bases: U = Unpunched/Solid  
Variable interior wall corner with four gauges from (3-5mm) 1/8-7/32"



## KÜBERIT WALL PROTECTION PROFILES

### KW-L

Pre-fit edge trim profile with rounded corners for walls:

- Used for ceramic tiles, floor coverings and as stair-nosing
- To be used with pre-fabricated corners/end caps (KW-M, KW-N)
- Installed using the appropriate adhesive
- Smooth surface

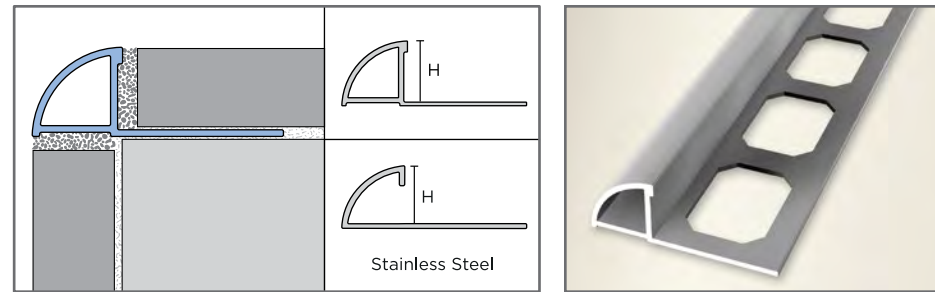

KW-L		A1	AP	SP
Length 2.50m = 8' 2-1/2"	Product Code	Anodized Aluminum Silver \$/Length	Anodized Aluminum Polished \$/Length	Stainless Steel Polished \$/Length
H = mm - in.	KW-L-000-	P	P	P
1 8mm 5/16"	KW-L-080-	✓	✓	✓
2 10mm 3/8"	KW-L-100-	✓	✓	✓

P = Punched/Perforated

### KW-M

Pre-fabricated exterior corner/end cap:

- Used for ceramic floor coverings and as stair-nosing
- Installed at the profile ends using the appropriate adhesive
- Smooth surface

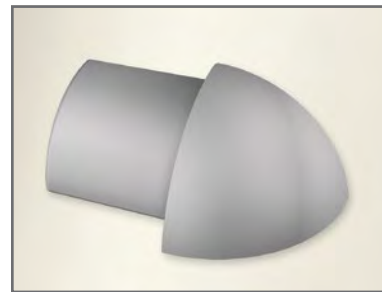
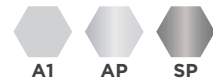

KW-M End Caps for KW-L		A1	AP	SP
Product Code		Anodized Aluminum Silver \$/Unit	Anodized Aluminum Polished \$/Unit	Stainless Steel Polished \$/Unit
H = mm - in.	KW-M-000-	(4 UNITS PER PACK)	(4 UNITS PER PACK)	(4 UNITS PER PACK)
1 8mm 5/16"	KW-M-080-	✓	✓	✓
2 10mm 3/8"	KW-M-100-	✓	✓	✓

### KW-N

Pre-fabricated interior corner/end cap:

- Used for ceramic floor coverings and as stair-nosing
- Installed using the appropriate adhesive
- Smooth surface

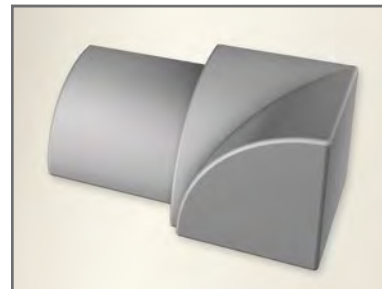

KW-N End Caps for KW-L		A1	AP	SP
Product Code		Anodized Aluminum Silver \$/Unit	Anodized Aluminum Polished \$/Unit	Stainless Steel Polished \$/Unit
H = mm - in.	KW-N-000-	(4 UNITS PER PACK)	(4 UNITS PER PACK)	(4 UNITS PER PACK)
1 8mm 5/16"	KW-N-080-	✓	✓	✓
2 10mm 3/8"	KW-N-100-	✓	✓	✓

## KÜBERIT WALL PROTECTION PROFILES

### KW-O

Edge trim with square corners for walls:

- Used for ceramic floor coverings and as stair-nosing
- To be used with pre-fabricated corner end caps (KW-P)
- Installed using the appropriate adhesive
- Smooth surface

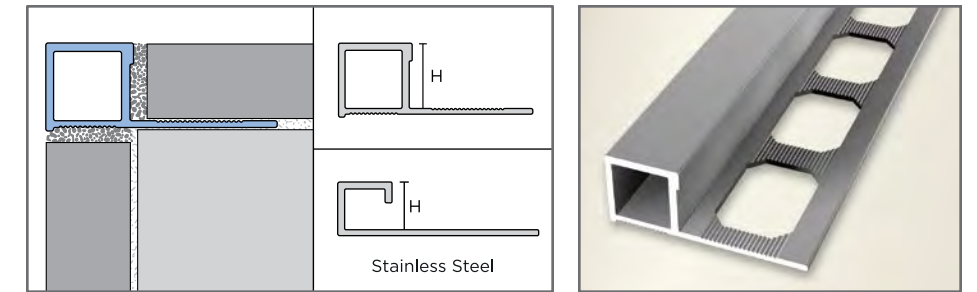
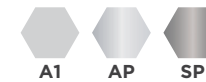

KW-O		A1	AP	SP
Length 2.50m = 8' 2-1/2"	Product Code	Anodized Aluminum Silver \$/Length	Anodized Aluminum Polished \$/Length	Stainless Steel Polished \$/Length
H = mm - in.	KW-O-000-	P	P	P
1 9mm 11/32"	KW-O-090-	✓	✓	✓
2 10mm 3/8"	KW-O-100-	✓	✓	✓
3 12.5mm 1/2"	KW-O-125-	✓	✓	✓

P = Punched/Perforated

### KW-P

Pre-fabricated interior/exterior corner/end cap:

- Used for ceramic floor coverings and as stair-nosing
- Installed using the appropriate adhesive
- Smooth surface

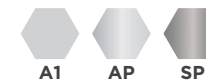

KW-P End Caps for KW-O		A1	AP	SP
Product Code		Anodized Aluminum Silver \$/Unit	Anodized Aluminum Polished \$/Unit	Stainless Steel Polished \$/Unit
H = mm - in.	KW-P-000-	(4 UNITS PER PACK)	(4 UNITS PER PACK)	(4 UNITS PER PACK)
1 9mm 11/32"	KW-P-090-	✓	✓	✓
2 10mm 3/8"	KW-P-100-	✓	✓	✓
3 12.5mm 1/2"	KW-P-125-	✓	✓	✓



KO-A-100-A1-U  
KW-Q-100-A1-P  
KW-R-100-A1  
KW-O-100-A1-P  
KW-P-100-A1

## KÜBERIT WALL PROTECTION PROFILES

### KW-Q

Pre-fit edge trims for walls can be used in corners and back-splashes:

- Used for ceramic floor coverings
- Protective and decorative
- Installed using the appropriate adhesive
- Available with pre-fabricated corners and end caps
- Smooth surface

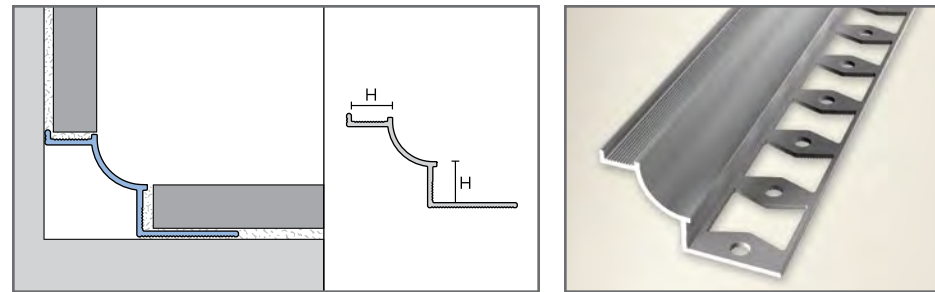

KW-Q			A1	AP
Length 2.50m = 8' 2-1/2"			Anodized Aluminum Silver \$/Length	Anodized Aluminum Polished \$/Length
Product Code			P	P
H = mm - in.			P	P
1	8mm	5/16"	✓	✓
2	10mm	3/8"	✓	✓

P = Punched/Perforated

### KW-R

Wall edge trim for exterior corner:

- Protective and decorative outer corner to be used with KW-Q
- Installed using the appropriate adhesive
- Pre-fabricated corners
- Smooth surface

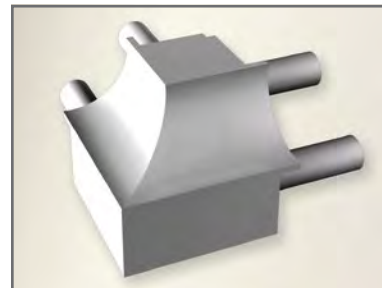

KW-R End Caps for KW-Q			A1	AP
Product Code			Anodized Aluminum Silver \$/Unit	Anodized Aluminum Polished \$/Unit
H = mm - in.			(4 UNITS PER PACK)	(4 UNITS PER PACK)
1	8mm	5/16"	✓	✓
2	10mm	3/8"	✓	✓

### KW-S

Wall edge trim for interior corner:

- Protective and decorative inner corner to be used with KW-Q
- Installed using the appropriate adhesive
- Pre-fabricated corners
- Smooth surface

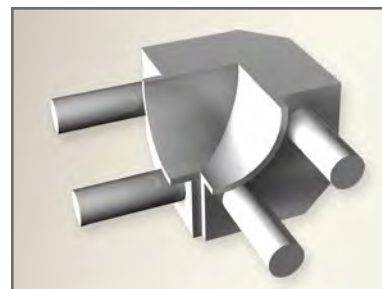

KW-S End Caps for KW-Q			A1	AP
Product Code			Anodized Aluminum Silver \$/Unit	Anodized Aluminum Polished \$/Unit
H = mm - in.			(4 UNITS PER PACK)	(4 UNITS PER PACK)
1	8mm	5/16"	✓	✓
2	10mm	3/8"	✓	✓

## KÜBERIT WALL PROTECTION PROFILES

### KW-T

Pre-fabricated end caps:

- Protective and decorative end caps to be used with KW-Q
- Installed using the appropriate adhesive
- Pre-fabricated left and right corners
- Smooth surface



KW-T End Caps for KW-Q			A1	AP
Product Code			Anodized Aluminum Silver \$/Unit	Anodized Aluminum Polished \$/Unit
H = mm - in.			(4 UNITS PER PACK)	(4 UNITS PER PACK)
1	8mm	5/16"	✓	✓
2	8mm	5/16"	✓	✓
3	10mm	3/8"	✓	✓
4	10mm	3/8"	✓	✓



**1. Terms and Conditions**

These terms and conditions of sale (“Terms”) control the sale of (“Products”) from Küberit USA, LLC (“KUSA” or “Seller”) to the purchasing entity identified on the quotation, order confirmation and/or invoice (“Customer”) where such products are to be used within the United States and its territories. “Product(s)” is defined as the items identified on the order confirmation or invoice, whichever is issued later by KUSA. A Product is “Custom-Made” if it is either (A) not included in the KUSA catalogue or (B) identified as such in the KUSA catalogue. The Terms herein, the terms and conditions contained on any order confirmation and/or invoice, and the terms and conditions contained in any applicable Credit Application, and/or supply agreement between KUSA and Customer, if any, represent the final and complete agreement of KUSA and Customer as to the sale and purchase of Products (the “Agreement”). In the event of any conflicting terms or conditions in the Agreement, the supply agreement, if any, shall be deemed to control; in the absence of a supply agreement, the order confirmation shall be deemed to control. Any and all different or additional terms other than those contained in the Agreement are rejected unless expressly accepted in writing by an authorized representative of KUSA.

**2. Changes/Cancellations/Returns**

Buyer shall not be entitled to revoke, defer or change any purchase order in process of production unless approved by Seller in writing on terms that will compensate Seller for all costs and expenses associated therewith. Custom-made products are not subject to order cancellation. Orders with tracking numbers are deemed shipped and any cancellation thereafter is deemed a “Return,” which will only be accepted if authorized in writing at the sole discretion of the Seller. Returns will incur a restocking fee of not less than thirty percent (30%) of the Product price, including shipping charges. Products may not be returned after 30 days under any circumstance. Any returned product must be in original condition and packing and subject to inspection by Seller prior to acceptance.

**3. Price and Payment**

Prices do not include sales taxes or other charges levied by any governmental authority upon the sale, use or transportation of the Products, all of which shall be paid by Customer, including, without limitation. Prices quoted in the KUSA catalog or KUSA price list are subject to change without prior notice. For the most current version of the Price List, please visit [www.kuberitusa.com](http://www.kuberitusa.com) or call customer service at 1-888-284-7567. Seller may withdraw from the Agreement and demand advance cash payments for further deliveries if Buyer is in default of any payment obligation.

Payment terms generally are net thirty (30) days from invoice date. No payments shall be subject to any set-offs, deductions or claims for any reason. For any amounts not paid by Customer as of the due date, Customer shall be liable to pay interest on the amount due at a rate of 1.5% per month from due date until date of payment in addition to the principal amount. Regardless of any statement appearing on a check or otherwise, KUSA acceptance of a payment in an amount less than that due shall in no way be an accord and satisfaction or prejudice KUSA rights and remedies to collect the full amount due.

**4. Shipping/Title/Risk of Loss**

Unless otherwise expressly set forth in writing by KUSA, all Products will be delivered Ex Works (as defined in International Commercial Terms 2017 revision). Shipment dates are estimated and not guaranteed. Oversized dimensions are not eligible for express shipping. Certain items with larger dimensions may not be eligible for parcel shipping and are subject to an additional charge. Title and risk of loss to Products shall transfer to Customer upon delivery in accordance with the applicable delivery terms. Any handling of the Products after transfer of risk of loss shall be at Customer’s sole risk.

**5. Freight and Shipping Charges**

Please note that there will be an additional ground transportation fee added to the orders shipped within the continental USA. Additional charges and handling fees may apply to Hawaii, Alaska and Canada. Expedited orders will be charged actual freight carrier costs. Standard profile lengths are 8’ 2-1/2”. Certain oversized items may not be eligible for express shipping.

**6. Product Inspection; Non-conformity**

Customer must inspect the Products upon delivery and notify KUSA in writing of any physical damage to the Products or nonconformity with the purchase order or invoice. Failure to inspect and deliver written notice of such damage or nonconformity within such forty-eight (48) hour period shall constitute irrevocable acceptance of the delivered products and a waiver of any damage or nonconformity that was or should have been detected. Any use of the Products or any portion thereof shall constitute irrevocable acceptance of such Products. As Customer’s sole remedy for any damaged or nonconforming Products of which Customer has delivered to KUSA timely notice of damaged or nonconforming Products, KUSA, at KUSA’s sole election, shall either: (A) replace the damaged or nonconforming Products, or (B) refund the price paid by Customer to KUSA for such damaged or nonconforming Products. In no event shall KUSA be liable for costs of procurement or substitute Products by Customer, or for injury or damage to business, or loss of profits, nor shall KUSA be liable for any incidental, special, indirect, or consequential damages. Any Product images are for illustrative purposes only; any differences between Product images and actual Product received shall not constitute nonconforming Product.

It is the responsibility of the Customer to control and inspect all Products upon delivery and notify the Seller in writing of any non-compliance with the order confirmation or invoice.

Profiles may exhibit color deviations due to the innate properties of the finishes and materials. Visual flaws, such as color deviations or die marks do not justify a claim based on defect. It is the responsibility of the Customer to verify color consistency before installation.

Oblique illumination effects, incidental vertical illuminations and light refraction effects shall be excluded from claims of defect. Wood veneer is a natural product that can have color deviations and growth-related irregularities. Such imperfections are therefore not defects in the case of profiles covered with wood veneer. Product images are for illustrative purposes only and any deviations between illustrations and Product does not constitute a claim for defect or non-compliance.

Failure to inspect the Products upon delivery, or any use of the Product or portion thereof, without notifying the Seller in writing of any damage or non-compliance within forty-eight (48) shall constitute acceptance of the Product and waive the rights to any claims as such.

If Buyer has delivered timely notice regarding damage or defect, the Seller shall either (A) replace the damaged or defect goods or (B) refund the price paid by Buyer for such products.

**7. Copyright/Industrial Property Rights for Custom-Made Products**

Customer may request special product(s) made to Customer’s specifications (“Special Products”) subject to Seller’s prior approval. If KUSA accepts an order for such Special Products, the Customer placing the order warrants that the product or drawing or sample or other information provided by the Customer does not infringe a registered patent, utility model, trademark right, etc. The tools/dies manufactured for such Special Product shall remain Seller’s intellectual property even if Customer paid all or a portion of the manufacturing cost, unless a different arrangement is made in writing. A right of surrender of such Special Product tools/dies shall not apply. The duty of Seller to maintain such tools/dies shall expire two years from the date of Customer’s last purchase order for the specific Special Product. The warranty for such Special Product also includes indemnity against third-party rights in respect of such Special Products and Customer will defend, at its own expense, any suit which may be brought against Seller by reason of the manufacture or sale of Special Products. In the case of cancellation of orders of Special Products, Customer’s cancellation may be conditioned upon Customer’s payment in full of the price of finished Special Products. KUSA will not accept any returns of Special Products.

**8. Warranty and Damages Disclaimer**

a. Warranty. The Products are covered by product-specific warranties, available at [www.kuberitusa.com](http://www.kuberitusa.com). The warranty that applies is the applicable warranty in effect for the Products as of the date of the proforma invoice, or if no proforma invoice, as of the date of the order acknowledgment for the Products (the “Written Warranty”).

b. Disclaimer. The written warranty is the only warranty applicable to the Products and excludes all other warranties, including, without limitation, any implied warranty of merchantability or fitness for a particular purpose, and any implied warranties otherwise arising from a course of dealing or usage of trade, except where purchase of the Products is subject to consumer product warranty laws, in which instances any applicable implied warranties are limited to the period of the applicable written warranty, or such shorter period as permitted or required under applicable law. In no event will Seller be liable for any incidental, special, indirect, or consequential damages, however caused, whether for breach of contract, breach of warranty, termination, negligence, or otherwise, even if Seller shall have been advised of the possibility of such damages.

Recommendations, advice, representations, warranties, commitments or agreements that are inconsistent with the foregoing disclaimer shall not be binding on KUSA unless in a writing signed by an authorized representative of KUSA. KUSA’s only obligation is to provide the Products in the quantities ordered by Customer (which order is accepted by KUSA) without regard to the Products’ appropriateness to Customer’s application. Customer represents and warrants that Customer is not a “consumer” as defined by any applicable usury or consumer protection laws.

**Warranty**

Seller warrants that the Products supplied by Seller shall be free from defects in workmanship and material and shall conform to the descriptions and specifications of the Product Data Sheet and standard industry guidelines for a period of five (5) years from the date of purchase when installed and used in accordance with Product Data Sheet and industry standards.

KUSA is not responsible or liable under any circumstances for determining the suitability of the Products for the Buyer’s intended purpose. It is the responsibility of the Buyer to consult with an experienced and professional installer to ensure the suitability of the Products.

Not covered with warranty: exact matching of color, shade, or texturing; damage caused by improper installation, use or maintenance; problems caused by moisture, hydrostatic pressure or alkali in the sub-floor; problems caused by installation with improper adhesive; Product installed outdoors; color degradation caused by sunlight or other UV exposure.

**9. Delay/Force Majeure**

Seller shall not be liable for any delay or non-delivery caused by circumstances beyond its reasonable control, including but not limited to: declared or undeclared war, fire, flood, explosions, strikes, labor trouble or shortages, accident, breakdowns, mechanical failure of machinery or equipment, riot, act of governmental authority, acts of God, unavoidable casualties, priorities required or requested by federal or any state government or any subdivision or agency thereof or granted for the benefit, directly or indirectly of any of them, failure of the usual sources of supplies of raw materials, supplies and equipment, including electrical energy, delays in transportation or lack of transportation facilities, restrictions imposed by federal or state legislation, rules, regulations, orders or ordinances, pandemics or other pervasive health-issues. In the event that any delivery is suspended or delayed by reason of the occurrence of one or more of the above causes, at Seller’s option, deliveries may be made after cessation of such causes and nothing herein shall excuse Buyer’s obligation to pay in full for any part of the order delivered before or after commencement of cessation of such cause(s).

**10. Choice of Law**

For sale of Products in the United States or its territories, the Agreement (including, without limitation, these Terms) shall be governed by the State of Alabama, without regard for its choice of law provisions.

**11. Arbitration**

a. Any controversy, claim or dispute arising out of or in connection with the Agreement shall be settled by final and binding arbitration administered by the American Arbitration Association in accordance with its Commercial Arbitration Rules in Florence, Lauderdale County, state of Alabama and judgment on the award rendered

by the arbitrator may be entered in any court having jurisdiction. The arbitration shall be heard by a single arbitrator appointed in accordance with the Commercial Arbitration Rules and shall be conducted in English.

b. If a controversy or claim relates to or is the subject of a mechanic’s or construction lien, KUSA may proceed in accordance with applicable law to preserve and enforce its lien rights. To the fullest extent permitted by law, notwithstanding any arbitration rule or procedure, (A) No controversy or claim arising out of or relating to the Agreement shall be consolidated or joined with any other person’s claim and no class action or representative actions shall be permitted under the Agreement, and (B) if any class or representative action cannot be waived under applicable law, the parties agree that such action shall be arbitrated.

**12. Miscellaneous**

No amendment, alteration, variation, deletion, addition, and/or cancellation of these Terms made by Customer shall be of any force or effect unless reduced to writing and signed by a director of KUSA. If any clause, sub-clause, or other provision of these Terms is invalid under any statute or rule of law, such provision, to that extent only, shall be deemed to be omitted without affecting the validity of the remainder of the Terms. Customer shall pay to KUSA all costs of collection, including, without limitation, reasonable attorneys’ fees, incurred by KUSA in enforcing the Agreement, including, without limitation, collecting any money due from Customer and enforcing KUSA’s lien rights. No waiver by KUSA of any term or any obligation of Customer shall constitute a waiver of any other term or obligation. Customer shall not assign or transfer its rights or obligations under the Agreement without the prior written consent of KUSA. All of Customer’s representations, warranties and indemnities under the Agreement shall survive the consummation of or the termination or cancellation of any purchase and sale of Products. Which party prepared the Agreement shall have no bearing on the construction or interpretation of the Agreement. Buyer will defend, at its own expense, any suit or legal proceeding, including any third-party proceedings, which may be brought against KUSA by reason of the manufacture or sale of any Special Product(s) made to Buyer’s specifications. These Terms supersede all prior versions of KUSA’s Conditions of Sale. KUSA reserves the right in its sole discretion to amend these Terms from time to time and any such amended terms and conditions shall be binding.

**ADA Compliance**

ADA requirements for the 3 classifications of level change between surfaces of different heights:

- 1) Vertical (up to 1/4”) - no bevel required
- 2) Beveled (1/4” to 1/2”) - bevel required at 1:2 slope
- 3) Ramp (1/2”->) - “ramp” required at 1:12 slope



ORDER INFORMATION

Place orders at [orders@kuberitusa.com](mailto:orders@kuberitusa.com)

Placing an order is as easy as 1, 2, 3.

To determine the item number when ordering, select:

1. Product Code 2. Finish 3. Option. (e.g. KO-A-030-A1-B)

Visit our website for current catalog pricing. [www.kuberitusa.com](http://www.kuberitusa.com)

KO-A			AN*			A1		A2	A3			A4	SP
Length 2.50m = 8' 2-1/2"	Product Code		Aluminum Natural \$/Length			Anodized Aluminum \$/Length		Sand \$/Length	Anodized Aluminum Bronze \$/Length			Anodized Aluminum Black \$/Length	Stainless Steel Polished \$/Length
	H = mm - in.	KO-A-000-	U	P	B	U	P		B	U	P	B	P
1	2mm	1/16"	KO-A-020-		✓		✓			✓		*✓	
2	2.5mm	3/32"	KO-A-025-	✓	✓		✓	✓		✓	✓		
3	3mm	1/8"	KO-A-030-	✓	✓	✓	✓	✓	✓	✓	✓	✓	✓
4	4.5mm	3/16"	KO-A-045-	✓	✓		✓	✓		✓	✓	✓	✓

1 Product Code 2 Material Finish 3 Profile Option

**Material Finishes**

Aluminum Natural

- AN Natural

Anodized Aluminum

- A1 Silver
- A2 Sand
- A3 Bronze
- A4 Black
- AP Polished
- AT Titanium

Stainless Steel  
304 (1.4301=V2A (E))

- SP Polished
- SB Brushed

Brass

- X1 Brass

Wood Decor

- W1 Oak Light
- W2 Oak Grey
- W3 Oak Beige Grey
- W4 Oak Cream
- W5 Oak Light Grey
- W6 Walnut
- W7 Wenge

**Insert Codes**

KE - Inserts

- BK Black
- GY Grey

KS - PVC Inserts

- 1 Black
- 2 Brown
- 3 Anthracite
- 4 Light Grey
- 5 Beige Grey
- 6 Beige
- 7 Blue
- 8 Red
- 9 Fluorescent
- 10 Yellow

**Symbols**

- Double-Sided
- ADA Compliant
- Screws Included  
Metric TORX
- Suggested Screws  
Phillips Flat Head  
Zinc-Plated

**Profile Options**

B = Bendable

C = Countersunk Drilled

P = Punched/Perforated

S = Self-Stick

U = Unpunched/Solid

**Maintenance**

Küberit profiles are made from the finest raw materials, using the latest technology. Please refer to the Product Data Sheet for maintenance instructions.

**Color Variation**

Color representation will vary slightly between our catalog, printouts, website and monitor displays. These cannot technically represent the true color of the materials or the different finishes/colors. Please feel free to order material and color samples from us.

**Profile Dimensions**

For detailed profile measurements, please refer to the Product Data Sheet.

**Conversions**

All conversions from mm to fractional inch are nominal.

**ADA Compliance**

Requirements for the 3 classifications of level change between surfaces of different heights:

- 1) Vertical (up to 1/4") No bevel required
- 2) Beveled (1/4" to 1/2") Bevel required at 1:2 slope
- 3) Ramp (1/2"->) "Ramp" required at 1:12 slope

**Color Variation:** Color representation will vary between our catalog, website, printouts and monitor displays. These cannot technically represent the true color of the materials and the different finishes/colors. Please feel free to order samples of materials and colors from us.

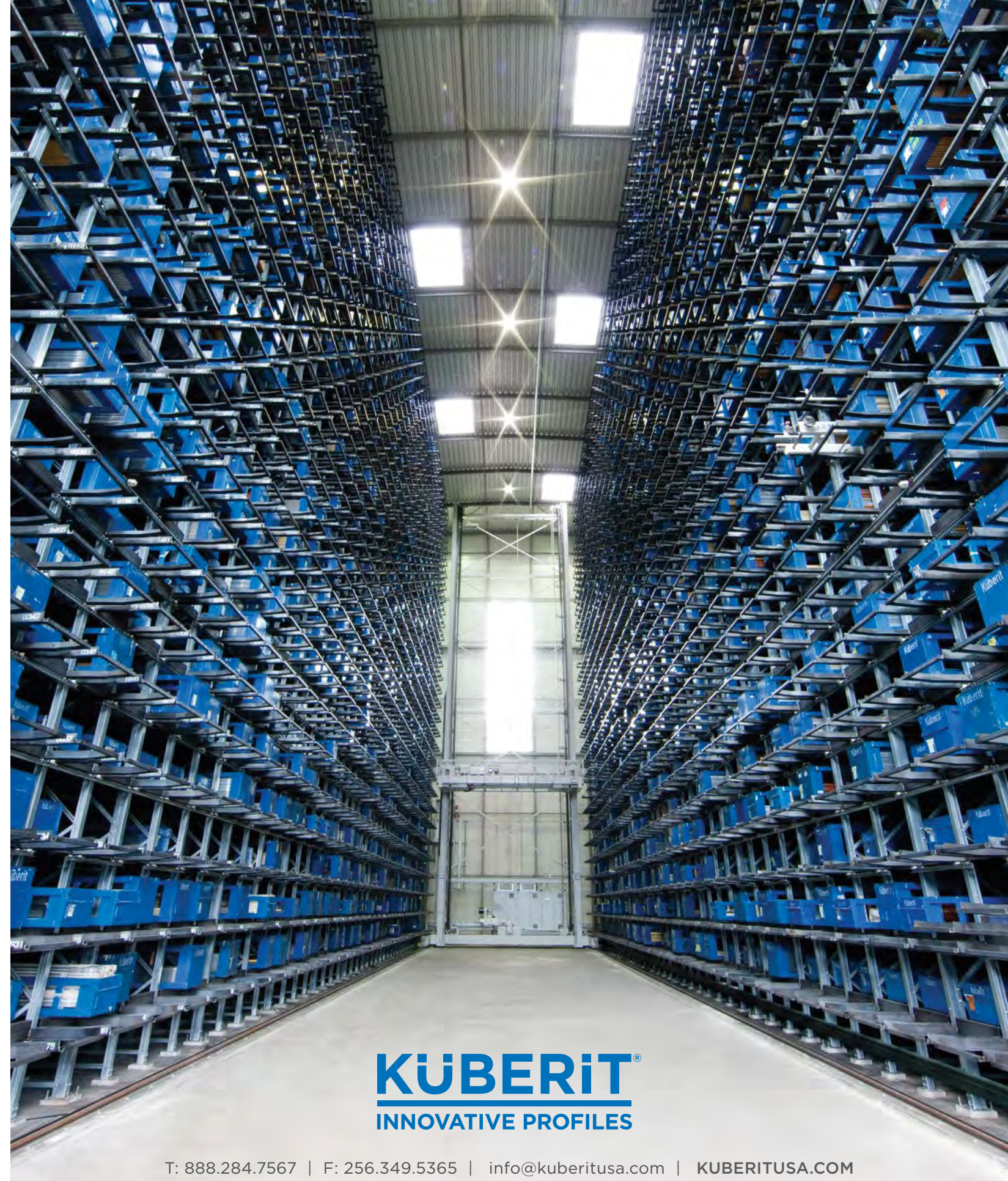

T: 888.284.7567 | F: 256.349.5365 | [info@kuberitusa.com](mailto:info@kuberitusa.com) | [KUBERITUSA.COM](http://KUBERITUSA.COM)

Küberit USA, LLC is a TMT America company.

A close-up, black and white photograph of several perforated metal profiles. The profiles are arranged in a crisscross pattern, creating a grid-like structure. The lighting highlights the texture and the repeating pattern of the perforations.

507 Wilhite Street  
Florence, AL 35630

T: 888.284.7567  
F: 256.349.5365

info@kuberitusa.com  
kuberitusa.com

**KÜBERIT**<sup>®</sup>  
INNOVATIVE PROFILES

Küberit USA, LLC  
is a TMT America company.

Printed Feb. 1, 2024